

LXinstruments GmbH
Rudolf-Diesel-Str. 36
71154 Nufringen
Germany



TECHNICAL PRODUCT INFORMATION

Test & measurement instruments

- high - quality
- moderate prices
- excellent precision

Your contact:

Technical support, services, demo & rental equipment, price information
& quotes, consulting:

Tel.: +49(0)7032 / 895 93-3

Mail: sales@lxinstruments.com

Web: www.lxinstruments.com

Shop: www.lxinstruments.com/shop

EL Series High-density Programmable DC Electronic Load



■ High Stability

■ High Precision

■ High Efficiency

EL Series High-density Programmable DC Electronic Load

EL Series High-density Programmable DC Electronic Load



(2U)600W~3000W



(3U)3400W~5600W



(4U)6600W~8100W



(7U)8800W~14700W



(10U)15400W~21300W



(13U)22000W~27900W

Voltage	Input		Model	Size	Resolution		Accuracy		Flippable Front Panel	Certificates
	Current	Power			Voltage	Current	Voltage	Current		
40V	620A	3400W	EL40VDC3400W	3U ²	0.1mV	0.5mA	0.015%+0.015%F.S.	0.1%+0.05%F.S.	NO	CE
	800A	4400W	EL40VDC4400W			0.5mA				
	1020A	5600W	EL40VDC5600W	1mA						
	1200A	6600W	EL40VDC6600W	1mA						
200V	60A	600W	EL200VDC600W	2U ¹	0.1mV	0.1mA	0.015%+0.015%F.S.	0.04%+0.04%F.S.	NO	CE
	130A	1200W	EL200VDC1200W			0.1mA				
	190A	1800W	EL200VDC1800W			0.1mA				
	260A	2400W	EL200VDC2400W			0.5mA				
	320A	3000W	EL200VDC3000W	0.5mA						
	370A	3400W	EL200VDC3400W	0.5mA						
	480A	4400W	EL200VDC4400W	0.5mA						
	610A	5600W	EL200VDC5600W	0.5mA						
	720A	6600W	EL200VDC6600W	0.5mA						
	720A	8100W	EL200VDC8100W	0.5mA						
	960A	8800W	EL200VDC8800W	1mA						
	960A	10300W	EL200VDC10300W	1mA						
	1200A	11000W	EL200VDC11000W	1mA						
	1200A	12500W	EL200VDC12500W	1mA						
	1440A	13200W	EL200VDC13200W	1mA						
	1440A	14700W	EL200VDC14700W	1mA						
	1680A	15400W	EL200VDC15400W	2mA						
	1680A	16900W	EL200VDC16900W	2mA						
	1920A	17600W	EL200VDC17600W	2mA						
	1920A	19100W	EL200VDC19100W	2mA						
2160A	19800W	EL200VDC19800W	2mA							
2160A	21300W	EL200VDC21300W	2mA							
2400A	22000W	EL200VDC22000W	4mA							
2400A	23500W	EL200VDC23500W	4mA							
2640A	24200W	EL200VDC24200W	4mA							
2640A	25700W	EL200VDC25700W	4mA							
2880A	26400W	EL200VDC26400W	4mA							
2880A	27900W	EL200VDC27900W	4mA							
600V	40A	600W	EL600VDC600W	2U ¹	0.5mV	0.1mA	0.015%+0.015%F.S.	0.04%+0.04%F.S.	NO	CE
	90A	1200W	EL600VDC1200W			0.1mA				
	130A	1800W	EL600VDC1800W			0.1mA				
	180A	2400W	EL600VDC2400W			0.2mA				
	220A	3000W	EL600VDC3000W	0.2mA						
	250A	3400W	EL600VDC3400W	0.4mA						
	320A	4400W	EL600VDC4400W	0.4mA						
	410A	5600W	EL600VDC5600W	0.4mA						
	480A	6600W	EL600VDC6600W	0.5mA						
	600A	8100W	EL600VDC8100W	0.5mA						
	640A	8800W	EL600VDC8800W	0.5mA						
	760A	10300W	EL600VDC10300W	0.5mA						
	800A	11000W	EL600VDC11000W	1mA						
	920A	12500W	EL600VDC12500W	1mA						
	960A	13200W	EL600VDC13200W	1mA						
	1080A	14700W	EL600VDC14700W	1mA						

EL Series High-density Programmable DC Electronic Load

Input			Model	Size	Resolution		Accuracy		Flippable Front Panel	Certificates	
Voltage	Current	Power			Voltage	Current	Voltage	Current			
600V	1600A	22000W	EL600VDC22000W	13U ^⑥	0.5mV	2mA	0.015%+0.015%F.S.	0.04%+0.04%F.S.	YES	CE	
	1720A	23500W	EL600VDC23500W			2mA					
	1760A	24200W	EL600VDC24200W			2mA					
	1880A	25700W	EL600VDC25700W			2mA					
	1920A	26400W	EL600VDC26400W			2mA					
	2040A	27900W	EL600VDC27900W			2mA					
1200V	45A	1200W	EL1200VDC1200W	2U ^①	1mV	0.1mA	0.015%+0.015%F.S.	0.04%+0.06%F.S.	NO		
	90A	2400W	EL1200VDC2400W	3U ^②		0.1mA					
	125A	3400W	EL1200VDC3400W			0.2mA					
	160A	4400W	EL1200VDC4400W	4U ^③		0.2mA					
	205A	5600W	EL1200VDC5600W			0.2mA					
	240A	6600W	EL1200VDC6600W	7U ^④		0.2mA					
	300A	8100W	EL1200VDC8100W			0.2mA					
	320A	8800W	EL1200VDC8800W			0.4mA					
	380A	10300W	EL1200VDC10300W			10U ^⑤					0.4mA
	400A	11000W	EL1200VDC11000W								0.4mA
	460A	12500W	EL1200VDC12500W			13U ^⑥					0.4mA
	480A	13200W	EL1200VDC13200W	0.4mA							
	540A	14700W	EL1200VDC14700W	0.4mA							
	560A	15400W	EL1200VDC15400W	1mA							
	620A	16900W	EL1200VDC16900W						0.5mA		
	640A	17600W	EL1200VDC17600W	1mA							
	700A	19100W	EL1200VDC19100W			0.5mA					
	720A	19800W	EL1200VDC19800W	1mA							
	780A	21300W	EL1200VDC21300W			0.5mA					
	800A	22000W	EL1200VDC22000W	1mA							
	860A	23500W	EL1200VDC23500W			1mA					
	880A	24200W	EL1200VDC24200W			1mA					
	940A	25700W	EL1200VDC25700W			1mA					
	960A	26400W	EL1200VDC26400W			1mA					
1020A	27900W	EL1200VDC27900W	1mA								

*Custom master slave system could extend to 558KW(20 units 27.9KW E-load parallel connect).

Dimensions & Weight



① 423.0x88.0x610.0mm & 18kg/20kg/22kg/24kg/26kg



② 423.0x133.0x610.0mm & 27kg/28.5kg/32.5kg



③ 423.0x177.0x610.0mm & 38kg



④ 423.0x311.0x670.0mm & 61.5kg/67kg/72.5kg



⑤ 423.0x444.0x670.0mm & 94.5kg/100kg/105.5kg



⑥ 423.0x577.0x670.0mm & 129kg/134.5kg/140kg

EL Series High-density Programmable DC Electronic Load

Optional Information

(1) LAN & GPIB interface card & cables



Features

- Flippable front panel and color touch screen allow convenient access and operation.
- Provides four kinds of basic working mode such as CV/CC/CR/CP, and CV+CC/CV+CR/CR+CC complex operating modes.
- Adjustable current slew rate, adjustable CV loop speed.
- Ultra high precision voltage & current measurement.
- OCP/OPP testing function.
- 50kHz high-speed CC/CR dynamic mode.
- 500kHz high-speed voltage and current sampling rate.
- Timing & discharging measurement for batteries.
- Short circuit test mode.
- Auto mode function provides an easy way to do complicated test.
- Dynamic frequency sweep function for determining worst case voltage peaks.*
- Non linear load mode function makes the simulated loading current more realistic.*
- Supports external analog control function
- V-monitor/I-monitor.
- LED load simulation function.
- Full protection: OCP, OPP, OTP, over voltage and reverse alarm.
- Maximum power point tracking*
- Up to 20 units master/slave parallel control.
- Front panel USB interface supports data import and export.
- SCPI language and standard rack size make it ideal for ATE System integration.
- Smart fan control with lower noise and better for environment.
- Multi versions to meet the cost performance and different applications.

* Only professional Electronic Load units support these functions.

Panel Introduction

Front Panel Description

- 1 Power switch
- 2 USB host, for data import and export
- 3 Color touch screen
- 4 Numeric keys and function keys
- 5 Function keys and multifunction keys
- 6 Enter key and arrow keys
- 7 Push-on knob, for editing parameter and moving the location of cursor
- 8 Ventilation holes
- 9 Stylus

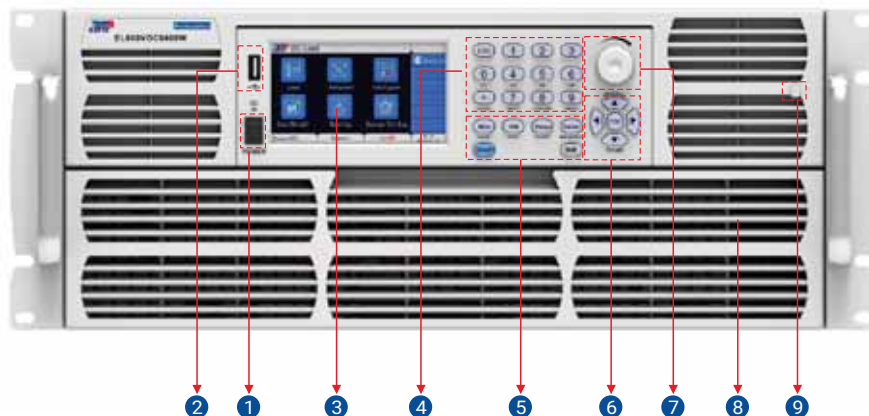

EL Series High-density Programmable DC Electronic Load

Rear Panel Description

- 1 Load positive/negative terminal
- 2 Remote sense connections
- 3 System Bus, for mater/slave system data transmission
- 4 RS485/RS232/USB communication Interface (standard), LAN&GPIB communication Interface (optional)*
- 5 External TTL/Analog control Interface
- 6 V-monitor/I-monitor
- 7 AC input connector
- 8 Ventilation holes

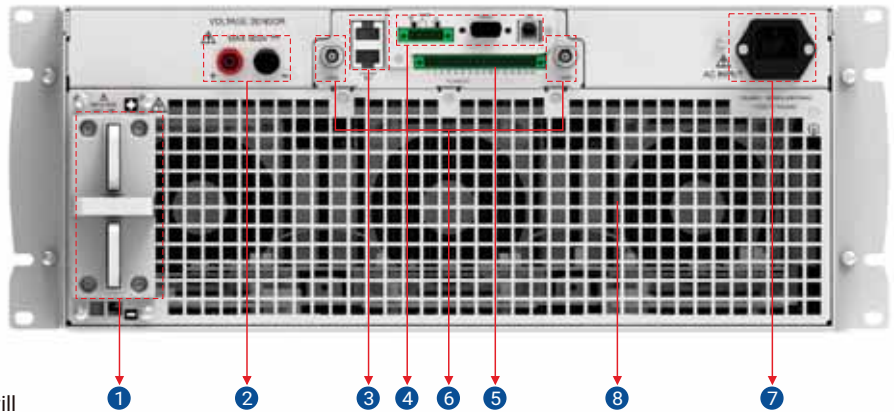

* When LAN&GPIB interface card selected it will be installed here instead of RS485/RS232/USB interface card.

Small Size, High Power Density

This series adopts high power density design. 8.1kW is with only 4U height.

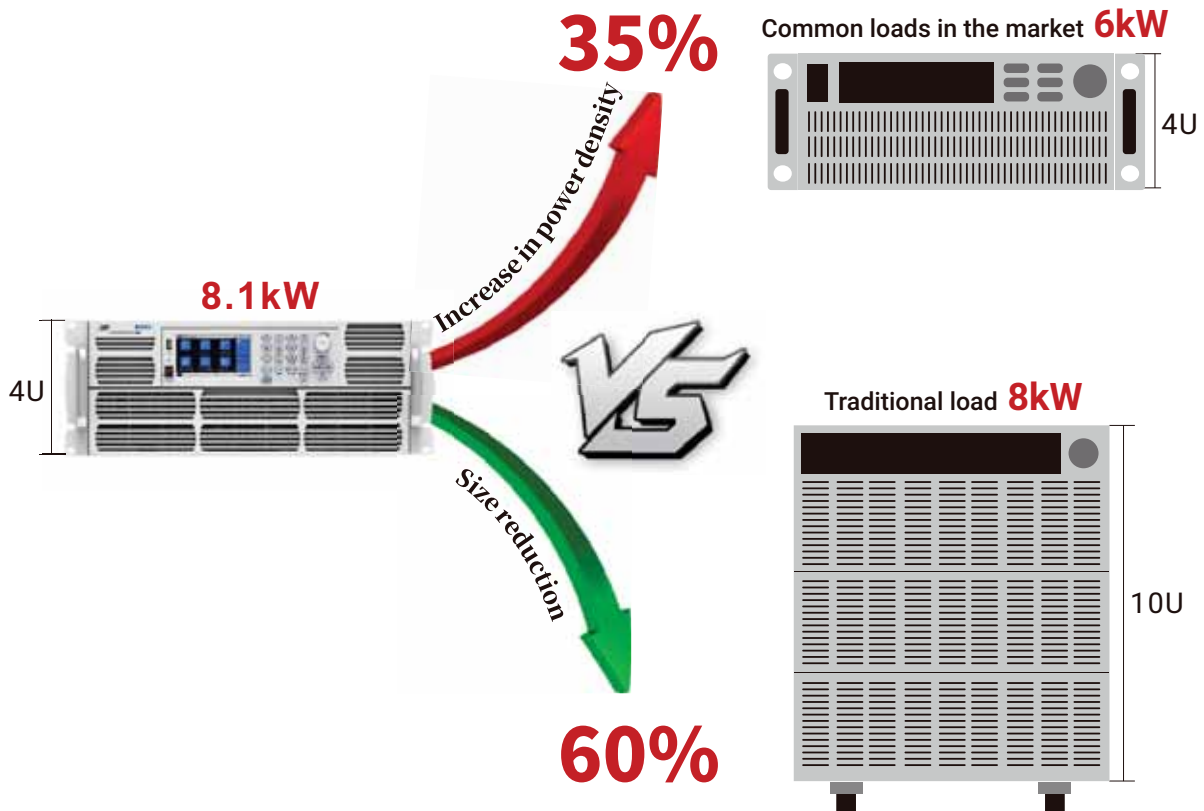

EL Series High-density Programmable DC Electronic Load

Function Introduction

Flippable Front Panel and Color Touch Screen

This series High Power DC Load is equipped with flippable front panel for 4U, 7U, 10U and 13U height models. Together with a large color touch screen provides simple and fast operation for customer. Real-time update of display input data, status and graphical display makes it more intuitive.



Multiple Operating Mode

Basic Operating Mode

This series High Power DC Load provides four kinds of basic operating mode including CV (constant voltage), CC (constant current), CR (constant resistance), CP (constant power), to satisfy a wide range of test requirements.

CC Mode

1. Load regulation test of DC power supply
2. Discharge time and life test for battery
3. Fuel cells test
4. Loading test for DC motor

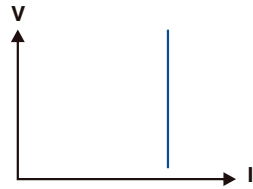

CV Mode

1. Charging station test
2. Current limit testing for Fold back type power supply
3. Fuel cells test
4. Current source test

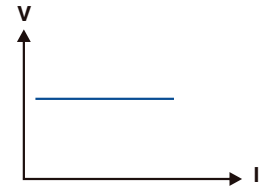

CR Mode

1. Slow start test for communication power supply
2. LED driver test
3. Loading test for automobile temperature controller

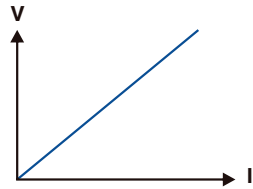

CP Mode

1. Testing for constant power type power supply
2. Capacity and life test for battery

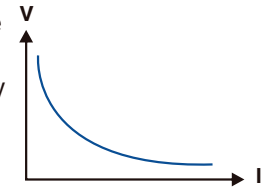

Complex Operating Mode

The CV+CC mode can be applied to the load simulation battery and test the charging station or the car charger.

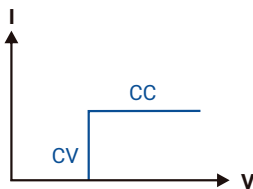

The CV+CR mode can be used to simulate the dynamic characteristics of LED.

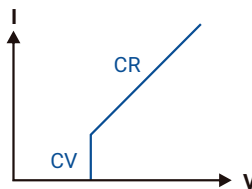

The CR+CC mode is suitable for power on testing.

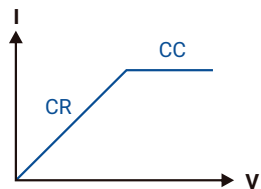

EL Series High-density Programmable DC Electronic Load

Adjustable CV Loop Speed

This series electronic load supports CV loop response speed setting to FAST, NORMAL or SLOW to satisfy different test requirements. This function may avoid the inaccurate measurement or testing fail caused by the response speed mismatch between the load and the power supply, which is possible to improve test efficiency and reduce costs on the equipments, time and expenses.

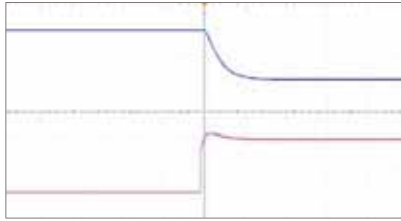

Slow speed of CV loop

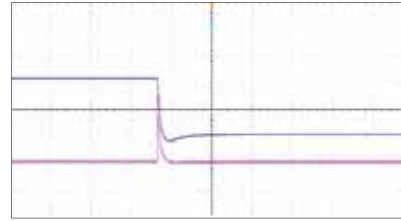

Normal speed of CV loop

Dynamic Load

This series electronic load can be switched quickly between different values in the same operating mode, including CC dynamic mode, CV dynamic mode, CR dynamic mode and CP dynamic mode, CC/CR high speed dynamic mode up to 50kHz.

This function is suitable for transient test of power supply, test of battery protection characteristic and battery pulse charging etc. Dynamic mode test has continuous mode, pulse mode and toggle mode.

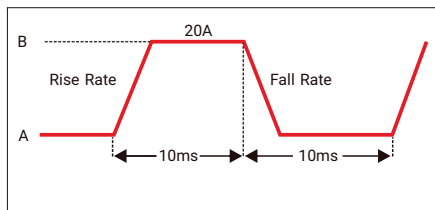

Continuous Mode

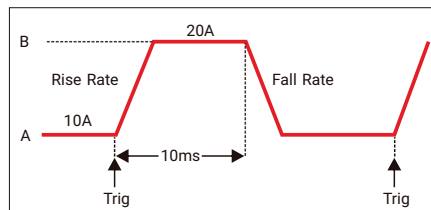

Pulse Mode

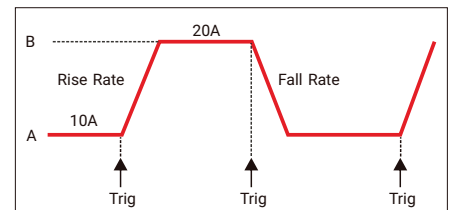

Toggle Mode

Sine Wave Dynamic Load

This series electronic load supports sine wave loading function which allows to load sine wave, can be used for impedance analysis test of fuel cells.

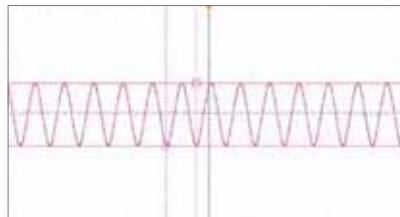

Dynamic Frequency Sweep Function

This series electronic load provides a unique constant current dynamic sweep to use frequency conversion to find out the UUT voltage of worst case.

This CC dynamic sweep allows the user to edit two load levels, start frequency, end frequency, step frequency, dwell etc.

The sampling rate is up to 500kHz, which make it can simulate different loading conditions for most test requirements.

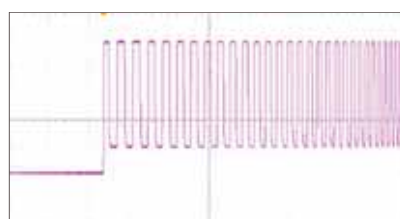

EL Series High-density Programmable DC Electronic Load

Maximum power point tracking (MPPT)

It can be applied to track the maximum power point of solar panels. Through the maximum power point tracking method, the maximum power point of the solar panel can be dynamically searched all the time, which can maximize the effectiveness of solar panels.

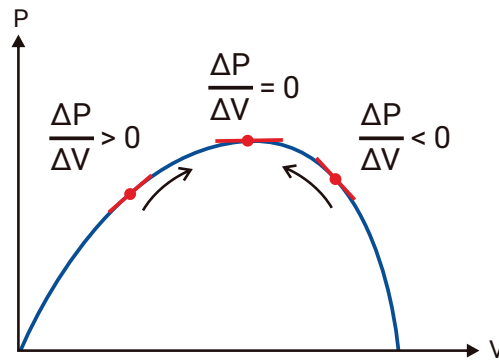

RLC

Simulating capacitive loads makes the current draw closer to the real situation. It is mainly applied for simulating capacitive loads turn on and turn off test. It can prevent the power supply from charging the capacitors on the motherboard when the power is turned on suddenly, which will cause the inrush current to trigger the power supply over-current protection and make the power supply fail to start smoothly.

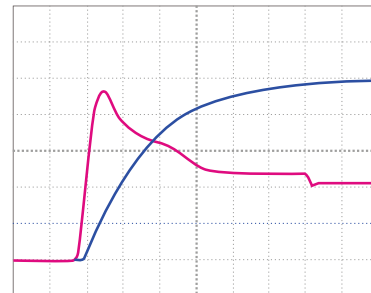
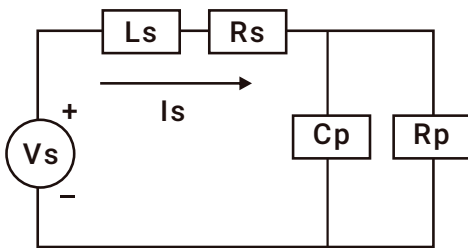

Battery Discharge Test

This series electronic load has battery discharge function, and can perform discharge test under CC, CR or CP mode. The DC load can set end voltage or time to stop loading correctly and make sure the battery is not damaged due to over discharge. The user can set stop conditions, whenever met any condition, the load will stop loading and counting automatically. During the test, users can observe battery's voltage, discharging time and already-discharged-capacity.

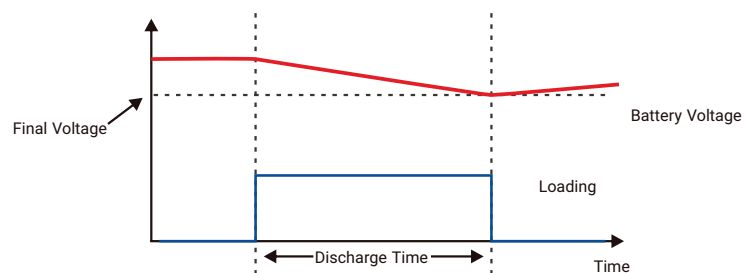

EL Series High-density Programmable DC Electronic Load

Auto Mode

This mode allows automatically switches among CV, CR, CC and CP modes. It is suitable for lithium ion battery charger testing to get a complete V-I charging curve. This flexible auto mode also enormously improve test efficiency.



OCP/OPP Tests

This series electronic load provides OCP and OPP modes are mainly applied in over-current and over-power points tests. After the testing the load can automatically judge the test result according to the set specifications. Take OPP testing as example, the OPP provides ramped up power for the load to test the UUT voltage whether has reached trigger voltage level and to judge if the protection is acting normally or not.

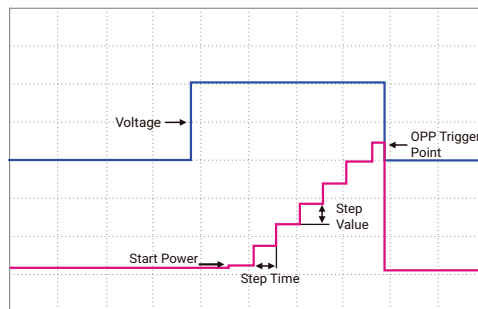

List Mode

The list function allows user to create waveform files to automatically simulate various complicated loading conditions. The list mode has 10 files, by editing operating mode (including CC, CV, CR, CP, Short and ON/OFF), repeat times, total steps, setting value of each step and step time etc. This function can be applied to the testing of output characteristic and stability for power supply.

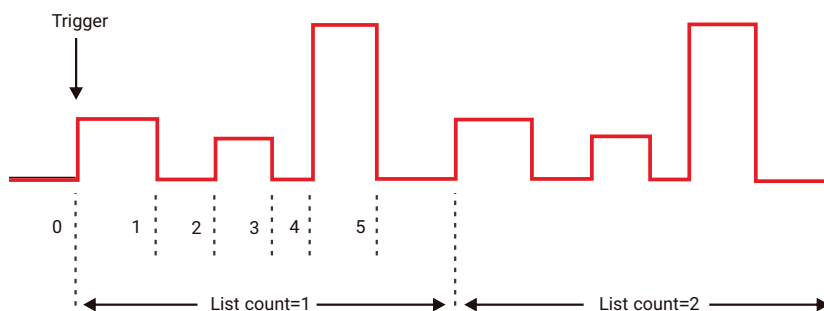

EL Series High-density Programmable DC Electronic Load

Master/Slave Control

This series electronic load provides the user with Master/slave mode, supports parallel connection under different power and same voltage and dynamically synchronized. In Master/slave mode, the user only need to control the master one, the load current will be automatically calculated and downloaded to the slave loads. The Master/slave mode greatly simplifies the operation when increased power is needed.

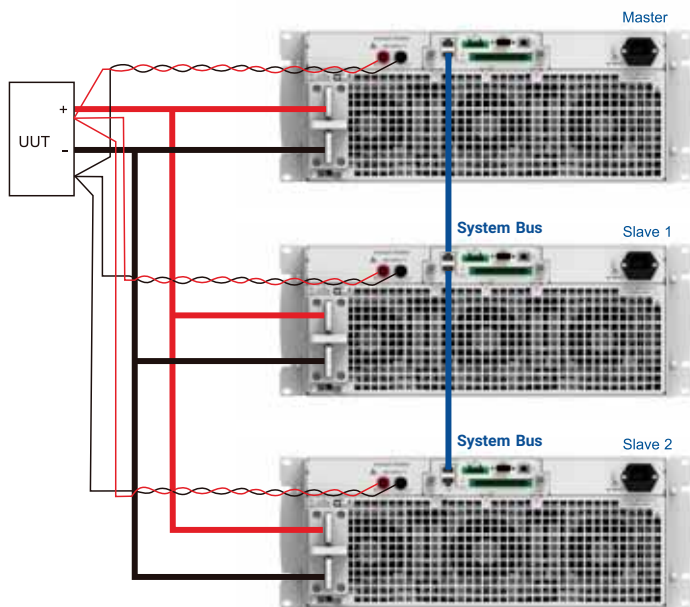

External Control and Current/Voltage Monitoring

This series electronic load has analog control interface to control the input voltage and current. The external signal 0 to 10V controls the sinking condition from 0 to full scale. Using the external control mode can simulate arbitrary waveform which is ideal for industrial control requirement.

The 0 to 10V analog output signal of V-MON/I-MON terminals represent input to which the terminals belong from 0 to full range. An external voltmeter or oscilloscope can be connected to display input voltage/current change.

Applications



New energy



Automotive electronics



Electronic component



Power supply



Battery charge/discharge test



ATE systems



R/D design verification/quality assurance



Factory production online test

EL Series High-density Programmable DC Electronic Load

MODEL		EL40VDC3400W			EL40VDC4400W		
Rated	Voltage	0~40V			0~40V		
	Current	0~620A			0~800A		
	Power	0~3400W			0~4400W		
	Min. Operating Voltage	0.3V/620A			0.3V/800A		
Static Mode							
Constant Current Mode	Range	0~62A	0~310A	0~620A	0~80A	0~400A	0~800A
	Resolution	0.5mA	2mA	5mA	0.5mA	2mA	5mA
	Accuracy	0.05%+0.05%F.S.			0.05%+0.05%F.S.		
Constant Voltage Mode	Range	0~5V	0~16V	0~40V	0~5V	0~16V	0~40V
	Resolution	0.1mV	0.2mV	0.5mV	0.1mV	0.2mV	0.5mV
	Accuracy	0.025%+0.025%F.S.			0.025%+0.025%F.S.		
Constant Power Mode	Range	0~340W	0~1700W	0~3400W	0~440W	0~2200W	0~4400W
	Resolution	10mW	50mW	100mW	10mW	50mW	100mW
	Accuracy	0.2%+0.2%F.S.			0.2%+0.2%F.S.		
Constant Resistance Mode	Range	0.5mΩ-12.5Ω(5V)	2.5mΩ-40Ω(16V)	5mΩ-100Ω(40V)	0.3mΩ~7.5Ω(5V)	1.5mΩ~30Ω(16V)	3mΩ~60Ω(40V)
	Resolution	0.1mΩ(5V)	0.5mΩ(16V)	1mΩ(40V)	0.1mΩ(5V)	0.5mΩ(16V)	1mΩ(40V)
	Accuracy	Vin/Rset*(0.2%)+0.2% I.F.S.			Vin/Rset*(0.2%)+0.2% I.F.S.		
Dynamic Mode							
CCD/CRD	T1&T2(Pro.)	0.02ms~300s			0.02ms~300s		
	T1&T2(Adv.)	0.05ms~300s			0.05ms~300s		
	Resolution	1μs			1μs		
	Accuracy	1μs+100ppm			1μs+100ppm		
	Slew Rate(Pro.)	0.5mA/μs~1.1A/μs	2mA/μs~5.5A/μs	5mA/μs~11A/μs	0.5mA/μs~1.4A/μs	2mA/μs~7A/μs	5mA/μs~14A/μs
	Slew Rate(Adv.)	0.5mA/μs~0.62A/μs	2mA/μs~3.1A/μs	5mA/μs~6.2A/μs	0.5mA/μs~0.80A/μs	2mA/μs~4A/μs	5mA/μs~8A/μs
	Min. Rise Time(Pro.)	50μs(Typical)			50μs(Typical)		
	Min. Rise Time(Adv.)	100μs(Typical)			100μs(Typical)		
	Resolution	0.5mA/μs	2mA/μs	5mA/μs	0.5mA/μs	2mA/μs	5mA/μs
	Accuracy	5%±10us			5%±10us		
Measurement							
Voltage	Range	0~5V	0~16V	0~40V	0~5V	0~16V	0~40V
	Resolution	0.1mV	0.2mV	0.5mV	0.1mV	0.2mV	0.5mV
	Accuracy	0.015%+0.015%F.S.			0.015%+0.015%F.S.		
Current	Range	0~62A	0~310A	0~620A	0~80A	0~400A	0~800A
	Resolution	0.5mA	2mA	5mA	0.5mA	2mA	5mA
	Accuracy	0.1%+0.05%F.S.			0.1%+0.05%F.S.		
Power	Range	0~340W	0~1700W	0~3400W	0~440W	0~2200W	0~4400W
	Resolution	10mW	50mW	100mW	10mW	50mW	100mW
	Accuracy	0.2%+0.2%F.S.			0.2%+0.2%F.S.		
Sampling Frequency	500kHz			500kHz			
Protection							
OVP	5.5V	17.6V	44V	5.5V	17.6V	44V	
OCP	63.2A	316.2A	632.4A	81.6A	408A	816A	
OPP	350.2W	1751W	3502W	453.2W	2266W	4532W	
Over Temperature	70-75°C			70-75°C			
Overvoltage Safety Value	110%VF.S.			110%VF.S.			
Reverse Alarm	Yes			Yes			
Alarm Tone	Yes			Yes			
Mechanical							
Dimensions(WxHxD)	423.0x133.0x610.0mm			423.0x133.0x610.0mm			
Package Dimensions(WxHxD)	665.0x348.0x918.0mm			665.0x348.0x918.0mm			
Unit Weight	27kg			28.5kg			
Shipping Weight	36kg			37.5kg			
AC Input							
Voltage	100~240Vac			100~240Vac			
Frequency	50~60Hz			50~60Hz			
Power	225VA			250VA			
Fuse	2.5A			2.5A			

EL Series High-density Programmable DC Electronic Load

MODEL		EL40VDC5600W			EL40VDC6600W		
Rated	Voltage	0~40V			0~40V		
	Current	0~1020A			0~1200A		
	Power	0~5600W			0~6600W		
	Min. Operating Voltage	0.3V/1020A			0.3V/1200A		
Static Mode							
Constant Current Mode	Range	0~102A	0~510A	0~1020A	0~120A	0~600A	0~1200A
	Resolution	1mA	5mA	10mA	1mA	5mA	10mA
	Accuracy	0.05%+0.05%F.S.			0.05%+0.05%F.S.		
Constant Voltage Mode	Range	0~5V	0~16V	0~40V	0~5V	0~16V	0~40V
	Resolution	0.1mV	0.2mV	0.5mV	0.1mV	0.2mV	0.5mV
	Accuracy	0.025%+0.025%F.S.			0.025%+0.025%F.S.		
Constant Power Mode	Range	0~560W	0~2800W	0~5600W	0~660W	0~3300W	0~6600W
	Resolution	10mW	50mW	100mW	10mW	50mW	100mW
	Accuracy	0.2%+0.2%F.S.			0.2%+0.2%F.S.		
Constant Resistance Mode	Range	0.2mΩ~5Ω(5V)	1mΩ~20Ω(16V)	2mΩ~40Ω(40V)	0.1mΩ~2.5Ω(5V)	0.5mΩ~10Ω(16V)	1mΩ~20Ω(40V)
	Resolution	0.1mΩ(5V)	0.5mΩ(16V)	1mΩ(40V)	0.1mΩ(5V)	0.5mΩ(16V)	1mΩ(40V)
	Accuracy	Vin/Rset*(0.2%)+0.2% I.F.S.			Vin/Rset*(0.2%)+0.2% I.F.S.		
Dynamic Mode							
CCD/CRD	T1&T2(Pro.)	0.02ms~300s			0.02ms~300s		
	T1&T2(Adv.)	0.05ms~300s			0.05ms~300s		
	Resolution	1μs			1μs		
	Accuracy	1μs+100ppm			1μs+100ppm		
	Slew Rate(Pro.)	1mA/μs~1.8A/μs	5mA/μs~9A/μs	10mA/μs~18A/μs	1mA/μs~2.2A/μs	5mA/μs~11A/μs	10mA/μs~22A/μs
	Slew Rate(Adv.)	1mA/μs~1.02A/μs	5mA/μs~5.1A/μs	10mA/μs~10.2A/μs	1mA/μs~1.2A/μs	5mA/μs~6A/μs	10mA/μs~12A/μs
	Min. Rise Time(Pro.)	50μs(Typical)			50μs(Typical)		
	Min. Rise Time(Adv.)	100μs(Typical)			100μs(Typical)		
	Resolution	1mA/μs	5mA/μs	10mA/μs	1mA/μs	5mA/μs	10mA/μs
	Accuracy	5%±10us			5%±10us		
Measurement							
Voltage	Range	0~5V	0~16V	0~40V	0~5V	0~16V	0~40V
	Resolution	0.1mV	0.2mV	0.5mV	0.1mV	0.2mV	0.5mV
	Accuracy	0.015%+0.015%F.S.			0.015%+0.015%F.S.		
Current	Range	0~102A	0~510A	0~1020A	0~120A	0~600A	0~1200A
	Resolution	1mA	5mA	10mA	1mA	5mA	10mA
	Accuracy	0.1%+0.05%F.S.			0.1%+0.05%F.S.		
Power	Range	0~560W	0~2800W	0~5600W	0~660W	0~3300W	0~6600W
	Resolution	10mW	50mW	100mW	10mW	50mW	100mW
	Accuracy	0.2%+0.2%F.S.			0.2%+0.2%F.S.		
Sampling Frequency	500kHz			500kHz			
Protection							
OVP	5.5V	17.6V	44V	5.5V	17.6V	44V	
OCP	104A	520.2A	1040.4A	122.4A	612A	1224A	
OPP	576.8W	2884W	5768W	679.8W	3399W	6798W	
Over Temperature	70-75°C			70-75°C			
Overvoltage Safety Value	110%VF.S.			110%VF.S.			
Reverse Alarm	Yes			Yes			
Alarm Tone	Yes			Yes			
Mechanical							
Dimensions(WxHxD)	423.0x133.0x610.0mm			423.0x177.0x610.0mm			
Package Dimensions(WxHxD)	665.0x348.0x918.0mm			665.0x392.0x918.0mm			
Unit Weight	32.5kg			38kg			
Shipping Weight	41.5kg			47kg			
AC Input							
Voltage	100~240Vac			100~240Vac			
Frequency	50~60Hz			50~60Hz			
Power	250VA			300VA			
Fuse	2.5A			3.15A			

EL Series High-density Programmable DC Electronic Load

40V Series System Specifications			
Non Linear Mode			
Range	CL	30uF~5000uF	
	RL	As CR Mode	
	Ls	0.1uH~16uH	
	Rs	30mΩ~20Ω	
Resolution	CL	1uF	
	RL	As CR Mode	
	Ls	0.1uH	
	Rs	1mΩ	
Battery Discharge Mode			
Battery Voltage	As CV Mode		
Current Resolution	As CC Mode		
Record	AH/WH		
Test Time	1s~100000s		
Time Resolution	1s		
Program Mode			
Step No.	300 Max.		
Dwell	0.1ms~4000s		
Spec Check	Voltage/Current/Power		
External Waveform Control/Monitor			
Control/Monitor	Voltage/Current		
Input/Output Range	0~10V		
Voltage Range	0~L_range F.S.	0~M_range F.S.	0~H_range F.S.
Current Range	0~L_range F.S.	0~M_range F.S.	0~H_range F.S.
Accuracy	0.4%F.S.		
Resolution	4mV		
Bandwidth	10kHz		
Input Impedance	10kΩ		
Short Circuit			
Current(CC)	Full range current value		
Voltage(CV)	Voltage value at the Max power in working mode		
Resistance(CR)	Min resistance value of CR Mode		
Master/Slave			
Parallel Interface	RJ45		
Parallel Quantity (Pro.)	20 units		
Parallel Quantity (Adv.)	20 units		
General			
Graphic Display	4.3" Color touch LCD		
Operation Key Feature	Soft key, Numeric key, Rotary Knob, USB port for transfer and upgrading firmware		
Rack Mount Handles	Yes		
FAN	Temperature Control		
Interface	RS232/RS485/USB(Standard), GPIB/LAN(Optional)		
Communication Response Time	30ms		
Storage Capacity	User defined settings (300 sets), OCP settings (10 sets), OPP settings (10 sets), Default settings (1 set), Factory setting (1 set)		
Environmental			
Operating Temperature	0~40°C		
Storage Temperature	-20~80°C		
Temperature Coefficient	100ppm/°C(Typical)		
Relative Humidity	10~90%RH		
Altitude	<2000m		
Regulatory Compliance			
Overvoltage Category	II		
Protection Degree	I		
Pollution Degree	II		
Input Impedance	200kΩ(Typical)		
Isolation Voltage	/		
Certificates	CE		

All specifications are subject to change without notice.

EL Series High-density Programmable DC Electronic Load

MODEL		EL200VDC600W			EL200VDC1200W		
Rated	Voltage	0~200V			0~200V		
	Current	0~60A			0~130A		
	Power	0~600W			0~1200W		
	Min. Operating Voltage	0.18V@6A	0.9V@30A	1.8V@60A	0.18V@13A	0.9V@65A	1.8V@130A
Static Mode							
Constant Current Mode	Range	0~6A	0~30A	0~60A	0~13A	0~65A	0~130A
	Resolution	0.1mA	0.5mA	2mA	0.1mA	0.5mA	2mA
	Accuracy	0.05%+0.05%F.S.			0.05%+0.05%F.S.		
Constant Voltage Mode	Range	0~16V	0~80V	0~200V	0~16V	0~80V	0~200V
	Resolution	0.1mV	0.5mV	2mV	0.1mV	0.5mV	2mV
	Accuracy	0.025%+0.025%F.S.			0.025%+0.025%F.S.		
Constant Power Mode	Range	0~60W	0~300W	0~600W	0~120W	0~600W	0~1200W
	Resolution	1mW	5mW	10mW	2mW	10mW	20mW
	Accuracy	0.2%+0.2%F.S.			0.2%+0.2%F.S.		
Constant Resistance Mode	Range	50mΩ~500Ω(16V)	200mΩ~2000Ω(80V)	5000mΩ~5000Ω(200V)	30mΩ~300Ω(16V)	120mΩ~1200Ω(80V)	3000mΩ~6000Ω(200V)
	Resolution	50mΩ(16V)	200mΩ(80V)	5000mΩ(200V)	30mΩ(16V)	120mΩ(80V)	3000mΩ(200V)
	Accuracy	Vin/Rset*(0.2%)+0.2% I.F.S.			Vin/Rset*(0.2%)+0.2% I.F.S.		
Dynamic Mode							
CCD/CRD	T1&T2(Pro.)	0.02ms~300s			0.02ms~300s		
	T1&T2(Adv.)	0.05ms~300s			0.05ms~300s		
	Resolution	1μs			1μs		
	Accuracy	1μs+100ppm			1μs+100ppm		
	Slew Rate(Pro.)	0.1mA/μs~0.24A/μs	0.5mA/μs~1.2A/μs	2mA/μs~2.4A/μs	0.1mA/μs~1.2A/μs	0.5mA/μs~3.6A/μs	2mA/μs~7.2A/μs
	Slew Rate(Adv.)	0.1mA/μs~0.06A/μs	0.5mA/μs~0.3A/μs	2mA/μs~0.6A/μs	0.1mA/μs~0.13A/μs	0.5mA/μs~0.65A/μs	2mA/μs~1.3A/μs
	Min. Rise Time(Pro.)	10μs(Typical)			10μs(Typical)		
	Min. Rise Time(Adv.)	50μs(Typical)			50μs(Typical)		
	Resolution	0.1mA/μs	0.5mA/μs	2mA/μs	0.1mA/μs	0.5mA/μs	2mA/μs
	Accuracy	5%±10us			5%±10us		
Measurement							
Voltage	Range	0~16V	0~80V	0~200V	0~16V	0~80V	0~200V
	Resolution	0.1mV	0.5mV	2mV	0.1mV	0.5mV	1mV
	Accuracy	0.015%+0.015%F.S.			0.015%+0.015%F.S.		
Current	Range	0~6A	0~30A	0~60A	0~13A	0~65A	0~130A
	Resolution	0.1mA	0.5mA	2mA	0.1mA	0.5mA	2mA
	Accuracy	0.04%+0.04%F.S.			0.04%+0.04%F.S.		
Power	Range	0~60W	0~300W	0~600W	0~120W	0~600W	0~1200W
	Resolution	1mW	5mW	10mW	2mW	10mW	20mW
	Accuracy	0.1%+0.1%F.S.			0.1%+0.1%F.S.		
Sampling Frequency	500kHz			500kHz			
Protection							
OVP	17.6V	88V	220V	17.6V	88V	220V	
OCP	6.12A	30.6A	61.2A	13.26A	66.3A	132.6A	
OPP	61.8W	309W	618W	123.6W	618W	1236W	
Over Temperature	70-75°C			70-75°C			
Overvoltage Safety Value	110%V.F.S.			110%V.F.S.			
Reverse Alarm	Yes			Yes			
Alarm Tone	Yes			Yes			
Mechanical							
Dimensions(WxHxD)	423.0x88.0x610.0mm			423.0x88.0x610.0 mm			
Package Dimensions(WxHxD)	665.0x333.0x918.0mm			665.0x333.0x918.0 mm			
Unit Weight	18kg			20kg			
Shipping Weight	27kg			29kg			
AC Input							
Voltage	100~240Vac			100~240Vac			
Frequency	50~60Hz			50~60Hz			
Power	100VA			125VA			
Fuse	2.5A			2.5A			

EL Series High-density Programmable DC Electronic Load

MODEL		EL200VDC1800W			EL200VDC2400W		
Rated	Voltage	0~200V			0~200V		
	Current	0~190A			0~260A		
	Power	0~1800W			0~2400W		
	Min. Operating Voltage	0.18V@19A	0.9V@95A	1.8V@190A	0.18V@26A	0.9V@130A	1.8V@260A
Static Mode							
Constant Current Mode	Range	0~19A	0~95A	0~190A	0~26A	0~130A	0~260A
	Resolution	0.1mA	0.5mA	2mA	0.5mA	2mA	5mA
	Accuracy	0.05%+0.05%F.S.			0.05%+0.05%F.S.		
Constant Voltage Mode	Range	0~16V	0~80V	0~200V	0~16V	0~80V	0~200V
	Resolution	0.1mV	0.5mV	2mV	0.1mV	0.5mV	2mV
	Accuracy	0.025%+0.025%F.S.			0.025%+0.025%F.S.		
Constant Power Mode	Range	0~180W	0~900W	0~1800W	0~240W	0~1200W	0~2400W
	Resolution	2mW	10mW	20mW	5mW	25mW	50mW
	Accuracy	0.2%+0.2%F.S.			0.2%+0.2%F.S.		
Constant Resistance Mode	Range	20mΩ~200Ω(16V)	80mΩ~800Ω(80V)	2000mΩ~4000Ω(200V)	15mΩ~150Ω(16V)	60mΩ~600Ω(80V)	1500mΩ~3000Ω(200V)
	Resolution	20mΩ(16V)	80mΩ(80V)	2000mΩ(200V)	15mΩ(16V)	60mΩ(80V)	1500mΩ(200V)
	Accuracy	Vin/Rset*(0.2%)+0.2% I.F.S.			Vin/Rset*(0.2%)+0.2% I.F.S.		
Dynamic Mode							
CCD/CRD	T1&T2(Pro.)	0.02ms~300s			0.02ms~300s		
	T1&T2(Adv.)	0.05ms~300s			0.05ms~300s		
	Resolution	1μs			1μs		
	Accuracy	1μs+100ppm			1μs+100ppm		
	Slew Rate(Pro.)	0.1mA/μs~1.8A/μs	0.5mA/μs~4.8A/μs	2mA/μs~9.6A/μs	0.5mA/μs~2.5A/μs	2mA/μs~7.5A/μs	5mA/μs~15A/μs
	Slew Rate(Adv.)	0.1mA/μs~0.19A/μs	0.5mA/μs~0.95A/μs	2mA/μs~1.9A/μs	0.5mA/μs~0.26A/μs	2mA/μs~1.3A/μs	5mA/μs~2.6A/μs
	Min. Rise Time(Pro.)	10μs(Typical)			10μs(Typical)		
	Min. Rise Time(Adv.)	50μs(Typical)			50μs(Typical)		
	Resolution	0.1mA/μs	0.5mA/μs	2mA/μs	0.5mA/μs	2mA/μs	5mA/μs
Accuracy	5%±10us			5%±10us			
Measurement							
Voltage	Range	0~16V	0~80V	0~200V	0~16V	0~80V	0~200V
	Resolution	0.1mV	0.5mV	2mV	0.1mV	0.5mV	2mV
	Accuracy	0.015%+0.015%F.S.			0.015%+0.015%F.S.		
Current	Range	0~19A	0~95A	0~190A	0~26A	0~130A	0~260A
	Resolution	0.1mA	0.5mA	2mA	0.5mA	2mA	5mA
	Accuracy	0.04%+0.04%F.S.			0.04%+0.04%F.S.		
Power	Range	0~180W	0~900W	0~1800W	0~240W	0~1200W	0~2400W
	Resolution	2mW	10mW	20mW	5mW	25mW	50mW
	Accuracy	0.1%+0.1%F.S.			0.1%+0.1%F.S.		
Sampling Frequency	500kHz			500kHz			
Protection							
OVP	17.6V	88V	220V	17.6V	88V	220V	
OCP	19.38A	96.9A	193.8A	26.52A	132.6A	265.2A	
OPP	185.4W	927W	1854W	247.2W	1236W	2472W	
Over Temperature	70-75°C			70-75°C			
Overvoltage Safety Value	110%V.F.S.			110%V.F.S.			
Reverse Alarm	Yes			Yes			
Alarm Tone	Yes			Yes			
Mechanical							
Dimensions(WxHxD)	423.0x88.0x610.0 mm			423.0x88.0x610.0 mm			
Package Dimensions(WxHxD)	665.0x333.0x918.0 mm			665.0x333.0x918.0 mm			
Unit Weight	22kg			24kg			
Shipping Weight	31kg			33kg			
AC Input							
Voltage	100~240Vac			100~240Vac			
Frequency	50~60Hz			50~60Hz			
Power	125VA			150VA			
Fuse	2.5A			2.5A			

EL Series High-density Programmable DC Electronic Load

MODEL		EL200VDC3000W			EL200VDC3400W		
Rated	Voltage	0~200V			0~200V		
	Current	0~320A			0~370A		
	Power	0~3000W			0~3400W		
	Min. Operating Voltage	0.18V@32A	0.9V@160A	1.8V@280A	0.18V@37A	0.9V@185A	1.8V@370A
Static Mode							
Constant Current Mode	Range	0~32A	0~160A	0~320A	0~37A	0~185A	0~370A
	Resolution	0.5mA	2mA	5mA	0.5mA	2mA	5mA
	Accuracy	0.05%+0.05%F.S.			0.05%+0.05%F.S.		
Constant Voltage Mode	Range	0~16V	0~80V	0~200V	0~16V	0~80V	0~200V
	Resolution	0.1mV	0.5mV	2mV	0.1mV	0.5mV	2mV
	Accuracy	0.025%+0.025%F.S.			0.025%+0.025%F.S.		
Constant Power Mode	Range	0~300W	0~1500W	0~3000W	0~340W	0~1700W	0~3400W
	Resolution	5mW	25mW	50mW	10mW	50mW	100mW
	Accuracy	0.2%+0.2%F.S.			0.2%+0.2%F.S.		
Constant Resistance Mode	Range	10mΩ~100Ω(16V)	40mΩ~400Ω(80V)	1000mΩ~2000Ω(200V)	10mΩ~100Ω(16V)	40mΩ~400Ω(80V)	1000mΩ~2000Ω(200V)
	Resolution	10mΩ(16V)	40mΩ(80V)	1000mΩ(200V)	10mΩ(16V)	40mΩ(80V)	1000mΩ(200V)
	Accuracy	Vin/Rset*(0.2%)+0.2% I.F.S.			Vin/Rset*(0.2%)+0.2% I.F.S.		
Dynamic Mode							
CCD/CRD	T1&T2(Pro.)	0.02ms~300s			0.02ms~300s		
	T1&T2(Adv.)	0.05ms~300s			0.05ms~300s		
	Resolution	1μs			1μs		
	Accuracy	1μs+100ppm			1μs+100ppm		
	Slew Rate(Pro.)	0.5mA/μs~3A/μs	2mA/μs~9A/μs	5mA/μs~18A/μs	0.5mA/μs~3.5A/μs	2mA/μs~10A/μs	5mA/μs~20A/μs
	Slew Rate(Adv.)	0.5mA/μs~0.32A/μs	2mA/μs~1.6A/μs	5mA/μs~3.2A/μs	0.5mA/μs~0.37A/μs	2mA/μs~1.85A/μs	5mA/μs~3.7A/μs
	Min. Rise Time(Pro.)	10μs(Typical)			10μs(Typical)		
	Min. Rise Time(Adv.)	50μs(Typical)			50μs(Typical)		
	Resolution	0.5mA/μs	2mA/μs	5mA/μs	0.5mA/μs	2mA/μs	5mA/μs
	Accuracy	5%±10us			5%±10us		
Measurement							
Voltage	Range	0~16V	0~80V	0~200V	0~16V	0~80V	0~200V
	Resolution	0.1mV	0.5mV	2mV	0.1mV	0.5mV	2mV
	Accuracy	0.015%+0.015%F.S.			0.015%+0.015%F.S.		
Current	Range	0~32A	0~160A	0~320A	0~37A	0~185A	0~370A
	Resolution	0.5mA	2mA	5mA	0.5mA	2mA	5mA
	Accuracy	0.04%+0.04%F.S.			0.04%+0.04%F.S.		
Power	Range	0~300W	0~1500W	0~3000W	0~340W	0~1700W	0~3400W
	Resolution	5mW	25mW	50mW	10mW	50mW	100mW
	Accuracy	0.1%+0.1%F.S.			0.1%+0.1%F.S.		
Sampling Frequency	500kHz			500kHz			
Protection							
OVP	17.6V	88V	220V	17.6V	88V	220V	
OCP	32.64A	163.2A	326.4A	37.74A	188.7A	377.4A	
OPP	309W	1545W	3090W	350.2W	1751W	3502W	
Over Temperature	70-75°C			70-75°C			
Overvoltage Safety Value	110%V.F.S.			110%V.F.S.			
Reverse Alarm	Yes			Yes			
Alarm Tone	Yes			Yes			
Mechanical							
Dimensions(WxHxD)	423.0x88.0x610.0 mm			423.0x133.0x610.0 mm			
Package Dimensions(WxHxD)	665.0x333.0x918.0 mm			665.0x348.0x918.0 mm			
Unit Weight	26kg			27kg			
Shipping Weight	35kg			36kg			
AC Input							
Voltage	100~240Vac			100~240Vac			
Frequency	50~60Hz			50~60Hz			
Power	180VA			225VA			
Fuse	2.5A			2.5A			

EL Series High-density Programmable DC Electronic Load

MODEL		EL200VDC4400W			EL200VDC5600W		
Rated	Voltage	0~200V			0~200V		
	Current	0~480A			0~610A		
	Power	0~4400W			0~5600W		
	Min. Operating Voltage	0.18V@48A	0.9V@240A	1.8V@480A	0.18V@61A	0.9V@305A	1.8V@610A
Static Mode							
Constant Current Mode	Range	0~48A	0~240A	0~480A	0~61A	0~305A	0~610A
	Resolution	0.5mA	2mA	5mA	0.5mA	2mA	5mA
	Accuracy	0.05%+0.05%F.S.			0.05%+0.05%F.S.		
Constant Voltage Mode	Range	0~16V	0~80V	0~200V	0~16V	0~80V	0~200V
	Resolution	0.1mV	0.5mV	2mV	0.1mV	0.5mV	2mV
	Accuracy	0.025%+0.025%F.S.			0.025%+0.025%F.S.		
Constant Power Mode	Range	0~440W	0~2200W	0~4400W	0~560W	0~2800W	0~5600W
	Resolution	10mW	50mW	100mW	10mW	50mW	100mW
	Accuracy	0.2%+0.2%F.S.			0.2%+0.2%F.S.		
Constant Resistance Mode	Range	7.5mΩ~75Ω(16V)	30mΩ~300Ω(80V)	750mΩ~1500Ω(200V)	7.5mΩ~75Ω(16V)	30mΩ~300Ω(80V)	750mΩ~1500Ω(200V)
	Resolution	7.5mΩ(16V)	30mΩ(80V)	750mΩ(200V)	7.5mΩ(16V)	30mΩ(80V)	750mΩ(200V)
	Accuracy	Vin/Rset*(0.2%)+0.2% I.F.S.			Vin/Rset*(0.2%)+0.2% I.F.S.		
Dynamic Mode							
CCD/CRD	T1&T2(Pro.)	0.02ms~300s			0.02ms~300s		
	T1&T2(Adv.)	0.05ms~300s			0.05ms~300s		
	Resolution	1μs			1μs		
	Accuracy	1μs+100ppm			1μs+100ppm		
	Slew Rate(Pro.)	0.5mA/μs~4.5A/μs	2mA/μs~12A/μs	5mA/μs~24A/μs	0.5mA/μs~5.6A/μs	2mA/μs~16A/μs	5mA/μs~32A/μs
	Slew Rate(Adv.)	0.5mA/μs~0.48A/μs	2mA/μs~2.4A/μs	5mA/μs~4.8A/μs	0.5mA/μs~0.61A/μs	2mA/μs~3.05A/μs	5mA/μs~6.1A/μs
	Min. Rise Time(Pro.)	10μs(Typical)			10μs(Typical)		
	Min. Rise Time(Adv.)	50μs(Typical)			50μs(Typical)		
	Resolution	0.5mA/μs	2mA/μs	5mA/μs	0.5mA/μs	2mA/μs	5mA/μs
Accuracy	5%±10us			5%±10us			
Measurement							
Voltage	Range	0~16V	0~80V	0~200V	0~16V	0~80V	0~200V
	Resolution	0.1mV	0.5mV	2mV	0.1mV	0.5mV	2mV
	Accuracy	0.015%+0.015%F.S.			0.015%+0.015%F.S.		
Current	Range	0~48A	0~240A	0~480A	0~61A	0~305A	0~610A
	Resolution	0.5mA	2mA	5mA	0.5mA	2mA	5mA
	Accuracy	0.04%+0.04%F.S.			0.04%+0.04%F.S.		
Power	Range	0~440W	0~2200W	0~4400W	0~560W	0~2800W	0~5600W
	Resolution	10mW	50mW	100mW	10mW	50mW	100mW
	Accuracy	0.1%+0.1%F.S.			0.1%+0.1%F.S.		
Sampling Frequency	500kHz			500kHz			
Protection							
OVP	17.6V	88V	220V	17.6V	88V	220V	
OCP	48.96A	244.8A	489.6A	62.22A	311.1A	622.2A	
OPP	453.2W	2266W	4532W	576.8W	2884W	5768W	
Over Temperature	70-75°C			70-75°C			
Overvoltage Safety Value	110%V.F.S.			110%V.F.S.			
Reverse Alarm	Yes			Yes			
Alarm Tone	Yes			Yes			
Mechanical							
Dimensions(WxHxD)	423.0x133.0x610.0 mm			423.0x133.0x610.0 mm			
Package Dimensions(WxHxD)	665.0x348.0x918.0 mm			665.0x348.0x918.0 mm			
Unit Weight	28.5kg			32.5kg			
Shipping Weight	37.5kg			41.5kg			
AC Input							
Voltage	100~240Vac			100~240Vac			
Frequency	50~60Hz			50~60Hz			
Power	250VA			250VA			
Fuse	2.5A			2.5A			

EL Series High-density Programmable DC Electronic Load

MODEL		EL200VDC6600W			EL200VDC8100W		
Rated	Voltage	0~200V			0~200V		
	Current	0~720A			0~720A		
	Power	0~6600W			0~8100W		
	Min. Operating Voltage	0.18V@72A	0.9V@360A	1.8V@720A	0.18V@72A	0.9V@360A	1.8V@720A
Static Mode							
Constant Current Mode	Range	0~72A	0~360A	0~720A	0~72A	0~360A	0~720A
	Resolution	0.5mA	2mA	5mA	0.5mA	2mA	5mA
	Accuracy	0.05%+0.05%F.S.			0.05%+0.05%F.S.		
Constant Voltage Mode	Range	0~16V	0~80V	0~200V	0~16V	0~80V	0~200V
	Resolution	0.1mV	0.5mV	2mV	0.1mV	0.5mV	2mV
	Accuracy	0.025%+0.025%F.S.			0.025%+0.025%F.S.		
Constant Power Mode	Range	0~660W	0~3300W	0~6600W	0~810W	0~4050W	0~8100W
	Resolution	10mW	50mW	100mW	10mW	50mW	100mW
	Accuracy	0.2%+0.2%F.S.			0.2%+0.2%F.S.		
Constant Resistance Mode	Range	5mΩ~50Ω(16V)	20mΩ~200Ω(80V)	500mΩ~1000Ω(200V)	5mΩ~50Ω(16V)	20mΩ~200Ω(80V)	500mΩ~1000Ω(200V)
	Resolution	5mΩ(16V)	20mΩ(80V)	500mΩ(200V)	5mΩ(16V)	20mΩ(80V)	500mΩ(200V)
	Accuracy	Vin/Rset*(0.2%)+0.2% I.F.S.			Vin/Rset*(0.2%)+0.2% I.F.S.		
Dynamic Mode							
CCD/CRD	T1&T2(Pro.)	0.02ms~300s			0.02ms~300s		
	T1&T2(Adv.)	0.05ms~300s			0.05ms~300s		
	Resolution	1μs			1μs		
	Accuracy	1μs+100ppm			1μs+100ppm		
	Slew Rate(Pro.)	0.5mA/μs~6A/μs	2mA/μs~18A/μs	5mA/μs~36A/μs	0.5mA/μs~6A/μs	2mA/μs~18A/μs	5mA/μs~36A/μs
	Slew Rate(Adv.)	0.5mA/μs~0.72A/μs	2mA/μs~3.6A/μs	5mA/μs~7.2A/μs	0.5mA/μs~0.72A/μs	2mA/μs~3.6A/μs	5mA/μs~7.2A/μs
	Min. Rise Time(Pro.)	10μs(Typical)			10μs(Typical)		
	Min. Rise Time(Adv.)	50μs(Typical)			50μs(Typical)		
	Resolution	0.5mA/μs	2mA/μs	5mA/μs	0.5mA/μs	2mA/μs	5mA/μs
Accuracy	5%±10us			5%±10us			
Measurement							
Voltage	Range	0~16V	0~80V	0~200V	0~16V	0~80V	0~200V
	Resolution	0.1mV	0.5mV	2mV	0.1mV	0.5mV	2mV
	Accuracy	0.015%+0.015%F.S.			0.015%+0.015%F.S.		
Current	Range	0~72A	0~360A	0~720A	0~72A	0~360A	0~720A
	Resolution	0.5mA	2mA	5mA	0.5mA	2mA	5mA
	Accuracy	0.04%+0.04%F.S.			0.04%+0.04%F.S.		
Power	Range	0~660W	0~3300W	0~6600W	0~810W	0~4050W	0~8100W
	Resolution	10mW	50mW	100mW	10mW	50mW	100mW
	Accuracy	0.1%+0.1%F.S.			0.1%+0.1%F.S.		
Sampling Frequency	500kHz			500kHz			
Protection							
OVP	17.6V	88V	220V	17.6V	88V	220V	
OCP	73.44A	367.2A	734.4A	73.44A	367.2A	734.4A	
OPP	679.8W	3399W	6798W	834.3W	4171.5W	8343W	
Over Temperature	70-75°C			70-75°C			
Overvoltage Safety Value	110%V.F.S.			110%V.F.S.			
Reverse Alarm	Yes			Yes			
Alarm Tone	Yes			Yes			
Mechanical							
Dimensions(WxHxD)	423.0x177.0x610.0 mm			423.0x177.0x610.0 mm			
Package Dimensions(WxHxD)	665.0x392.0x918.0 mm			665.0x392.0x918.0 mm			
Unit Weight	38kg			42kg			
Shipping Weight	47kg			51kg			
AC Input							
Voltage	100~240Vac			100~240Vac			
Frequency	50~60Hz			50~60Hz			
Power	300VA			350VA			
Fuse	3.15A			3.15A			

EL Series High-density Programmable DC Electronic Load

MODEL		EL200VDC8800W			EL200VDC10300W		
Rated	Voltage	0~200V			0~200V		
	Current	0~960A			0~960A		
	Power	0~8800W			0~10300W		
	Min. Operating Voltage	0.18V@96A	0.9V@480A	1.8V@960A	0.18V@96A	0.9V@480A	1.8V@960A
Static Mode							
Constant Current Mode	Range	0~96A	0~480A	0~960A	0~96A	0~480A	0~960A
	Resolution	1mA	5mA	10mA	1mA	5mA	10mA
	Accuracy	0.05%+0.05%F.S.			0.05%+0.05%F.S.		
Constant Voltage Mode	Range	0~16V	0~80V	0~200V	0~16V	0~80V	0~200V
	Resolution	0.1mV	0.5mV	2mV	0.1mV	0.5mV	2mV
	Accuracy	0.025%+0.025%F.S.			0.025%+0.025%F.S.		
Constant Power Mode	Range	0~880W	0~4400W	0~8800W	0~1030W	0~5150W	0~10300W
	Resolution	20mW	100mW	200mW	20mW	100mW	200mW
	Accuracy	0.2%+0.2%F.S.			0.2%+0.2%F.S.		
Constant Resistance Mode	Range	4mΩ~40Ω(16V)	15mΩ~150Ω(80V)	375mΩ~750Ω(200V)	4mΩ~40Ω(16V)	15mΩ~150Ω(80V)	375mΩ~750Ω(200V)
	Resolution	4mΩ(16V)	15mΩ(80V)	375mΩ(200V)	4mΩ(16V)	15mΩ(80V)	375mΩ(200V)
	Accuracy	Vin/Rset*(0.2%)+0.2% I.F.S.			Vin/Rset*(0.2%)+0.2% I.F.S.		
Dynamic Mode							
CCD/CRD	T1&T2(Pro.)	0.02ms~300s			0.02ms~300s		
	T1&T2(Adv.)	0.05ms~300s			0.05ms~300s		
	Resolution	1μs			1μs		
	Accuracy	1μs+100ppm			1μs+100ppm		
	Slew Rate(Pro.)	1mA/μs~7.2A/μs	5mA/μs~21A/μs	10mA/μs~42A/μs	1mA/μs~7.2A/μs	5mA/μs~21A/μs	10mA/μs~42A/μs
	Slew Rate(Adv.)	1mA/μs~0.96A/μs	5mA/μs~4.8A/μs	10mA/μs~9.6A/μs	1mA/μs~0.96A/μs	5mA/μs~4.8A/μs	10mA/μs~9.6A/μs
	Min. Rise Time(Pro.)	10μs(Typical)			10μs(Typical)		
	Min. Rise Time(Adv.)	50μs(Typical)			50μs(Typical)		
	Resolution	1mA/μs	5mA/μs	10mA/μs	1mA/μs	5mA/μs	10mA/μs
	Accuracy	5%±10us			5%±10us		
Measurement							
Voltage	Range	0~16V	0~80V	0~200V	0~16V	0~80V	0~200V
	Resolution	0.1mV	0.5mV	2mV	0.1mV	0.5mV	2mV
	Accuracy	0.015%+0.015%F.S.			0.015%+0.015%F.S.		
Current	Range	0~96A	0~480A	0~960A	0~96A	0~480A	0~960A
	Resolution	1mA	5mA	10mA	1mA	5mA	10mA
	Accuracy	0.04%+0.04%F.S.			0.04%+0.04%F.S.		
Power	Range	0~880W	0~4400W	0~8800W	0~1030W	0~5150W	0~10300W
	Resolution	20mW	100mW	200mW	20mW	100mW	200mW
	Accuracy	0.1%+0.1%F.S.			0.1%+0.1%F.S.		
Sampling Frequency	500kHz			500kHz			
Protection							
OVP	17.6V	88V	220V	17.6V	88V	220V	
OCP	97.92A	489.6A	979.2A	97.92A	489.6A	979.2A	
OPP	906.4W	4532W	9064W	1060.9W	5304.5W	10609W	
Over Temperature	70-75°C			70-75°C			
Overvoltage Safety Value	110%V.F.S.			110%V.F.S.			
Reverse Alarm	Yes			Yes			
Alarm Tone	Yes			Yes			
Mechanical							
Dimensions(WxHxD)	423.0x311.0x670.0 mm			423.0x311.0x670.0 mm			
Package Dimensions(WxHxD)	541.0x591.0x891.0 mm			541.0x591.0x891.0 mm			
Unit Weight	61.5kg			65.5kg			
Shipping Weight	81.5kg			85.5kg			
AC Input							
Voltage	100~240Vac			100~240Vac			
Frequency	50~60Hz			50~60Hz			
Power	450VA			500VA			
Fuse	5A			5A			

EL Series High-density Programmable DC Electronic Load

MODEL		EL200VDC11000W			EL200VDC12500W		
Rated	Voltage	0~200V			0~200V		
	Current	0~1200A			0~1200A		
	Power	0~11000W			0~12500W		
	Min. Operating Voltage	0.18V@120A	0.9V@600A	1.8V@1200A	0.18V@120A	0.9V@600A	1.8V@1200A
Static Mode							
Constant Current Mode	Range	0~120A	0~600A	0~1200A	0~120A	0~600A	0~1200A
	Resolution	1mA	5mA	10mA	1mA	5mA	10mA
	Accuracy	0.05%+0.05%F.S.			0.05%+0.05%F.S.		
Constant Voltage Mode	Range	0~16V	0~80V	0~200V	0~16V	0~80V	0~200V
	Resolution	0.1mV	0.5mV	2mV	0.1mV	0.5mV	2mV
	Accuracy	0.025%+0.025%F.S.			0.025%+0.025%F.S.		
Constant Power Mode	Range	0~1100W	0~5500W	0~11000W	0~1250W	0~6250W	0~12500W
	Resolution	20mW	100mW	200mW	20mW	100mW	200mW
	Accuracy	0.2%+0.2%F.S.			0.2%+0.2%F.S.		
Constant Resistance Mode	Range	3mΩ~30Ω(16V)	12mΩ~120Ω(80V)	300mΩ~600Ω(200V)	3mΩ~30Ω(16V)	12mΩ~120Ω(80V)	300mΩ~600Ω(200V)
	Resolution	3mΩ(16V)	12mΩ(80V)	300mΩ(200V)	3mΩ(16V)	12mΩ(80V)	300mΩ(200V)
	Accuracy	Vin/Rset*(0.2%)+0.2% I.F.S.			Vin/Rset*(0.2%)+0.2% I.F.S.		
Dynamic Mode							
CCD/CRD	T1&T2(Pro.)	0.02ms~300s			0.02ms~300s		
	T1&T2(Adv.)	0.05ms~300s			0.05ms~300s		
	Resolution	1μs			1μs		
	Accuracy	1μs+100ppm			1μs+100ppm		
	Slew Rate(Pro.)	1mA/μs~8A/μs	5mA/μs~24A/μs	10mA/μs~48A/μs	1mA/μs~8A/μs	5mA/μs~24A/μs	10mA/μs~48A/μs
	Slew Rate(Adv.)	1mA/μs~1.2A/μs	5mA/μs~6A/μs	10mA/μs~12A/μs	1mA/μs~1.2A/μs	5mA/μs~6A/μs	10mA/μs~12A/μs
	Min. Rise Time(Pro.)	10μs(Typical)			10μs(Typical)		
	Min. Rise Time(Adv.)	50μs(Typical)			50μs(Typical)		
	Resolution	1mA/μs	5mA/μs	10mA/μs	1mA/μs	5mA/μs	10mA/μs
	Accuracy	5%±10us			5%±10us		
Measurement							
Voltage	Range	0~16V	0~80V	0~200V	0~16V	0~80V	0~200V
	Resolution	0.1mV	0.5mV	2mV	0.1mV	0.5mV	2mV
	Accuracy	0.015%+0.015%F.S.			0.015%+0.015%F.S.		
Current	Range	0~120A	0~600A	0~1200A	0~120A	0~600A	0~1200A
	Resolution	1mA	5mA	10mA	1mA	5mA	10mA
	Accuracy	0.04%+0.04%F.S.			0.04%+0.04%F.S.		
Power	Range	0~1100W	0~5500W	0~11000W	0~1250W	0~6250W	0~12500W
	Resolution	20mW	100mW	200mW	20mW	100mW	200mW
	Accuracy	0.1%+0.1%F.S.			0.1%+0.1%F.S.		
Sampling Frequency	500kHz			500kHz			
Protection							
OVP	17.6V	88V	220V	17.6V	88V	220V	
OCP	122.4A	612A	1224A	122.4A	612A	1224A	
OPP	1133W	5665W	11330W	1287.5W	6437.5W	12875W	
Over Temperature	70-75°C			70-75°C			
Overvoltage Safety Value	110%V.F.S.			110%V.F.S.			
Reverse Alarm	Yes			Yes			
Alarm Tone	Yes			Yes			
Mechanical							
Dimensions(WxHxD)	423.0x311.0x670.0 mm			423.0x311.0x670.0 mm			
Package Dimensions(WxHxD)	541.0x591.0x891.0 mm			541.0x591.0x891.0 mm			
Unit Weight	67kg			71kg			
Shipping Weight	87kg			91kg			
AC Input							
Voltage	100~240Vac			100~240Vac			
Frequency	50~60Hz			50~60Hz			
Power	500VA			550VA			
Fuse	5A			5A			

EL Series High-density Programmable DC Electronic Load

MODEL		EL200VDC13200W			EL200VDC14700W		
Rated	Voltage	0~200V			0~200V		
	Current	0~1440A			0~1440A		
	Power	0~13200W			0~14700W		
	Min. Operating Voltage	0.18V@144A	0.9V@720A	1.8V@1440A	0.18V@144A	0.9V@720A	1.8V@1440A
Static Mode							
Constant Current Mode	Range	0~144A	0~720A	0~1440A	0~144A	0~720A	0~1440A
	Resolution	1mA	5mA	10mA	1mA	5mA	10mA
	Accuracy	0.05%+0.05%F.S.			0.05%+0.05%F.S.		
Constant Voltage Mode	Range	0~16V	0~80V	0~200V	0~16V	0~80V	0~200V
	Resolution	0.1mV	0.5mV	2mV	0.1mV	0.5mV	2mV
	Accuracy	0.025%+0.025%F.S.			0.025%+0.025%F.S.		
Constant Power Mode	Range	0~1320W	0~6600W	0~13200W	0~1470W	0~7350W	0~14700W
	Resolution	40mW	200mW	400mW	40mW	200mW	400mW
	Accuracy	0.2%+0.2%F.S.			0.2%+0.2%F.S.		
Constant Resistance Mode	Range	2.5mΩ~25Ω(16V)	10mΩ~100Ω(80V)	250mΩ~500Ω(200V)	2.5mΩ~25Ω(16V)	10mΩ~100Ω(80V)	250mΩ~500Ω(200V)
	Resolution	2.5mΩ(16V)	10mΩ(80V)	250mΩ(200V)	2.5mΩ(16V)	10mΩ(80V)	250mΩ(200V)
	Accuracy	Vin/Rset*(0.2%)+0.2% I.F.S.			Vin/Rset*(0.2%)+0.2% I.F.S.		
Dynamic Mode							
CCD/CRD	T1&T2(Pro.)	0.02ms~300s			0.02ms~300s		
	T1&T2(Adv.)	0.05ms~300s			0.05ms~300s		
	Resolution	1μs			1μs		
	Accuracy	1μs+100ppm			1μs+100ppm		
	Slew Rate(Pro.)	1mA/μs~9.6A/μs	5mA/μs~28.8A/μs	10mA/μs~57.6A/μs	1mA/μs~9.6A/μs	5mA/μs~28.8A/μs	10mA/μs~57.6A/μs
	Slew Rate(Adv.)	1mA/μs~1.44A/μs	5mA/μs~7.2A/μs	10mA/μs~14.4A/μs	1mA/μs~1.44A/μs	5mA/μs~7.2A/μs	10mA/μs~14.4A/μs
	Min. Rise Time(Pro.)	10μs(Typical)			10μs(Typical)		
	Min. Rise Time(Adv.)	50μs(Typical)			50μs(Typical)		
	Resolution	1mA/μs	5mA/μs	10mA/μs	1mA/μs	5mA/μs	10mA/μs
	Accuracy	5%±10us			5%±10us		
Measurement							
Voltage	Range	0~16V	0~80V	0~200V	0~16V	0~80V	0~200V
	Resolution	0.1mV	0.5mV	2mV	0.1mV	0.5mV	2mV
	Accuracy	0.015%+0.015%F.S.			0.015%+0.015%F.S.		
Current	Range	0~144A	0~720A	0~1440A	0~144A	0~720A	0~1440A
	Resolution	1mA	5mA	10mA	1mA	5mA	10mA
	Accuracy	0.04%+0.04%F.S.			0.04%+0.04%F.S.		
Power	Range	0~1320W	0~6600W	0~13200W	0~1470W	0~7350W	0~14700W
	Resolution	40mW	200mW	400mW	40mW	200mW	400mW
	Accuracy	0.1%+0.1%F.S.			0.1%+0.1%F.S.		
Sampling Frequency	500kHz			500kHz			
Protection							
OVP	17.6V	88V	220V	17.6V	88V	220V	
OCP	146.88A	734.4A	1468.8A	146.88A	734.4A	1468.8A	
OPP	1359.6W	6798W	13596W	1514.1W	7570.5W	15141W	
Over Temperature	70-75°C			70-75°C			
Overvoltage Safety Value	110%V.F.S.			110%V.F.S.			
Reverse Alarm	Yes			Yes			
Alarm Tone	Yes			Yes			
Mechanical							
Dimensions(WxHxD)	423.0x311.0x670.0 mm			423.0x311.0x670.0 mm			
Package Dimensions(WxHxD)	541.0x591.0x891.0 mm			541.0x591.0x891.0 mm			
Unit Weight	72.5kg			76.5kg			
Shipping Weight	92.5kg			96.5kg			
AC Input							
Voltage	100~240Vac			100~240Vac			
Frequency	50~60Hz			50~60Hz			
Power	550VA			600VA			
Fuse	5A			5A			

EL Series High-density Programmable DC Electronic Load

MODEL		EL200VDC15400W			EL200VDC16900W		
Rated	Voltage	0~200V			0~200V		
	Current	0~1680A			0~1680A		
	Power	0~15400W			0~16900W		
	Min. Operating Voltage	0.18V@168A	0.9V@840A	1.8V@1680A	0.18V@168A	0.9V@840A	1.8V@1680A
Static Mode							
Constant Current Mode	Range	0~168A	0~840A	0~1680A	0~168A	0~840A	0~1680A
	Resolution	2mA	10mA	20mA	2mA	10mA	20mA
	Accuracy	0.05%+0.05%F.S.			0.05%+0.05%F.S.		
Constant Voltage Mode	Range	0~16V	0~80V	0~200V	0~16V	0~80V	0~200V
	Resolution	0.1mV	0.5mV	2mV	0.1mV	0.5mV	2mV
	Accuracy	0.025%+0.025%F.S.			0.025%+0.025%F.S.		
Constant Power Mode	Range	0~1540W	0~7700W	0~15400W	0~1690W	0~8450W	0~8450W
	Resolution	40mW	200mW	400mW	40mW	200mW	400mW
	Accuracy	0.2%+0.2%F.S.			0.2%+0.2%F.S.		
Constant Resistance Mode	Range	2.5mΩ~25Ω(16V)	10mΩ~100Ω(80V)	250mΩ~500Ω(200V)	2.5mΩ~25Ω(16V)	10mΩ~100Ω(80V)	250mΩ~500Ω(200V)
	Resolution	2.5mΩ(16V)	10mΩ(80V)	250mΩ(200V)	2.5mΩ(16V)	10mΩ(80V)	250mΩ(200V)
	Accuracy	Vin/Rset*(0.2%)+0.2% I.F.S.			Vin/Rset*(0.2%)+0.2% I.F.S.		
Dynamic Mode							
CCD/CRD	T1&T2(Pro.)	0.02ms~300s			0.02ms~300s		
	T1&T2(Adv.)	0.05ms~300s			0.05ms~300s		
	Resolution	1μs			1μs		
	Accuracy	1μs+100ppm			1μs+100ppm		
	Slew Rate(Pro.)	2mA/μs~11.2A/μs	10mA/μs~32A/μs	20mA/μs~64A/μs	2mA/μs~11.2A/μs	10mA/μs~32A/μs	20mA/μs~64A/μs
	Slew Rate(Adv.)	2mA/μs~1.68A/μs	10mA/μs~8.4A/μs	20mA/μs~16.8A/μs	2mA/μs~1.68A/μs	10mA/μs~8.4A/μs	20mA/μs~16.8A/μs
	Min. Rise Time(Pro.)	10μs(Typical)			10μs(Typical)		
	Min. Rise Time(Adv.)	50μs(Typical)			50μs(Typical)		
	Resolution	2mA/μs	10mA/μs	20mA/μs	2mA/μs	10mA/μs	20mA/μs
	Accuracy	5%±10us			5%±10us		
Measurement							
Voltage	Range	0~16V	0~80V	0~200V	0~16V	0~80V	0~200V
	Resolution	0.1mV	0.5mV	2mV	0.1mV	0.5mV	2mV
	Accuracy	0.015%+0.015%F.S.			0.015%+0.015%F.S.		
Current	Range	0~168A	0~840A	0~1680A	0~168A	0~840A	0~1680A
	Resolution	2mA	10mA	20mA	2mA	10mA	20mA
	Accuracy	0.04%+0.04%F.S.			0.04%+0.04%F.S.		
Power	Range	0~1540W	0~7700W	0~15400W	0~1690W	0~8450W	0~16900W
	Resolution	40mW	200mW	400mW	40mW	200mW	400mW
	Accuracy	0.1%+0.1%F.S.			0.1%+0.1%F.S.		
Sampling Frequency	500kHz			500kHz			
Protection							
OVP	17.6V	88V	220V	17.6V	88V	220V	
OCP	171.36A	856.8A	1713.6A	171.36A	856.8A	1713.6A	
OPP	1586.2W	7931W	15862W	1740.7W	8703.5W	17407W	
Over Temperature	70-75°C			70-75°C			
Overvoltage Safety Value	110%V.F.S.			110%V.F.S.			
Reverse Alarm	Yes			Yes			
Alarm Tone	Yes			Yes			
Mechanical							
Dimensions(WxHxD)	423.0x444.0x670.0 mm			423.0x444.0x670.0 mm			
Package Dimensions(WxHxD)	544.0x741.0x891.0 mm			544.0x741.0x891.0 mm			
Unit Weight	94.5kg			98.5kg			
Shipping Weight	116.5kg			120.5kg			
AC Input							
Voltage	100~240Vac			100~240Vac			
Frequency	50~60Hz			50~60Hz			
Power	700VA			750VA			
Fuse	8A			8A			

EL Series High-density Programmable DC Electronic Load

MODEL		EL200VDC17600W			EL200VDC19100W		
Rated	Voltage	0~200V			0~200V		
	Current	0~1920A			0~1920A		
	Power	0~17600W			0~19100W		
	Min. Operating Voltage	0.18V@192A	0.9V@960A	1.8V@1920A	0.18V@192A	0.9V@960A	1.8V@1920A
Static Mode							
Constant Current Mode	Range	0~192A	0~960A	0~1920A	0~192A	0~960A	0~1920A
	Resolution	2mA	10mA	20mA	2mA	10mA	20mA
	Accuracy	0.05%+0.05%F.S.			0.05%+0.05%F.S.		
Constant Voltage Mode	Range	0~16V	0~80V	0~200V	0~16V	0~80V	0~200V
	Resolution	0.1mV	0.5mV	2mV	0.1mV	0.5mV	2mV
	Accuracy	0.025%+0.025%F.S.			0.025%+0.025%F.S.		
Constant Power Mode	Range	0~1760W	0~8800W	0~17600W	0~1910W	0~9550W	0~19100W
	Resolution	100mW	500mW	1000mW	100mW	500mW	1000mW
	Accuracy	0.2%+0.2%F.S.			0.2%+0.2%F.S.		
Constant Resistance Mode	Range	2mΩ~20Ω(16V)	7.5mΩ~75Ω(80V)	200mΩ~400Ω(200V)	2mΩ~20Ω(16V)	7.5mΩ~75Ω(80V)	200mΩ~400Ω(200V)
	Resolution	2mΩ(16V)	7.5mΩ(80V)	200mΩ(200V)	2mΩ(16V)	7.5mΩ(80V)	200mΩ(200V)
	Accuracy	Vin/Rset*(0.2%)+0.2% I.F.S.			Vin/Rset*(0.2%)+0.2% I.F.S.		
Dynamic Mode							
CCD/CRD	T1&T2(Pro.)	0.02ms~300s			0.02ms~300s		
	T1&T2(Adv.)	0.05ms~300s			0.05ms~300s		
	Resolution	1μs			1μs		
	Accuracy	1μs+100ppm			1μs+100ppm		
	Slew Rate(Pro.)	2mA/μs~12.8A/μs	10mA/μs~34A/μs	20mA/μs~68A/μs	2mA/μs~12.8A/μs	10mA/μs~34A/μs	20mA/μs~68A/μs
	Slew Rate(Adv.)	2mA/μs~1.92A/μs	10mA/μs~9.6A/μs	20mA/μs~19.2A/μs	2mA/μs~1.92A/μs	10mA/μs~9.6A/μs	20mA/μs~19.2A/μs
	Min. Rise Time(Pro.)	10μs(Typical)			10μs(Typical)		
	Min. Rise Time(Adv.)	50μs(Typical)			50μs(Typical)		
	Resolution	2mA/μs	10mA/μs	20mA/μs	2mA/μs	10mA/μs	20mA/μs
	Accuracy	5%±10us			5%±10us		
Measurement							
Voltage	Range	0~16V	0~80V	0~200V	0~16V	0~80V	0~200V
	Resolution	0.1mV	0.5mV	2mV	0.1mV	0.5mV	2mV
	Accuracy	0.015%+0.015%F.S.			0.015%+0.015%F.S.		
Current	Range	0~192A	0~960A	0~1920A	0~192A	0~960A	0~1920A
	Resolution	2mA	10mA	20mA	2mA	10mA	20mA
	Accuracy	0.04%+0.04%F.S.			0.04%+0.04%F.S.		
Power	Range	0~1760W	0~8800W	0~17600W	0~1910W	0~9550W	0~19100W
	Resolution	100mW	500mW	1000mW	100mW	500mW	1000mW
	Accuracy	0.1%+0.1%F.S.			0.1%+0.1%F.S.		
Sampling Frequency	500kHz			500kHz			
Protection							
OVP	17.6V	88V	220V	17.6V	88V	220V	
OCP	195.84A	979.2A	1958.4A	195.84A	979.2A	1958.4A	
OPP	1812.8W	9064W	18128W	1967.3W	9836.5W	19673W	
Over Temperature	70-75°C			70-75°C			
Overvoltage Safety Value	110%V.F.S.			110%V.F.S.			
Reverse Alarm	Yes			Yes			
Alarm Tone	Yes			Yes			
Mechanical							
Dimensions(WxHxD)	423.0x444.0x670.0 mm			423.0x444.0x670.0 mm			
Package Dimensions(WxHxD)	544.0x741.0x891.0 mm			544.0x741.0x891.0 mm			
Unit Weight	100kg			104kg			
Shipping Weight	122kg			126kg			
AC Input							
Voltage	100~240Vac			100~240Vac			
Frequency	50~60Hz			50~60Hz			
Power	750VA			800VA			
Fuse	8A			8A			

EL Series High-density Programmable DC Electronic Load

MODEL		EL200VDC19800W			EL200VDC21300W		
Rated	Voltage	0~200V			0~200V		
	Current	0~2160A			0~2160A		
	Power	0~19800W			0~21300W		
	Min. Operating Voltage	0.18V@216A	0.9V@1080A	1.8V@2160A	0.18V@216A	0.9V@1080A	1.8V@2160A
Static Mode							
Constant Current Mode	Range	0~216A	0~1080A	0~2160A	0~216A	0~1080A	0~2160A
	Resolution	2mA	10mA	20mA	2mA	10mA	20mA
	Accuracy	0.05%+0.05%F.S.			0.05%+0.05%F.S.		
Constant Voltage Mode	Range	0~16V	0~80V	0~200V	0~16V	0~80V	0~200V
	Resolution	0.1mV	0.5mV	2mV	0.1mV	0.5mV	2mV
	Accuracy	0.025%+0.025%F.S.			0.025%+0.025%F.S.		
Constant Power Mode	Range	0~1980W	0~9900W	0~19800W	0~2130W	0~10650W	0~21300W
	Resolution	100mW	500mW	1000mW	100mW	500mW	1000mW
	Accuracy	0.2%+0.2%F.S.			0.2%+0.2%F.S.		
Constant Resistance Mode	Range	1.7mΩ~16.7Ω(16V)	6.7mΩ~66.7Ω(80V)	166.7mΩ~333Ω(200V)	1.7mΩ~16.7Ω(16V)	6.7mΩ~66.7Ω(80V)	166.7mΩ~333Ω(200V)
	Resolution	1.7mΩ(16V)	6.7mΩ(80V)	166.7mΩ(200V)	1.7mΩ(16V)	6.7mΩ(80V)	166.7mΩ(200V)
	Accuracy	Vin/Rset*(0.2%)+0.2% I.F.S.			Vin/Rset*(0.2%)+0.2% I.F.S.		
Dynamic Mode							
CCD/CRD	T1&T2(Pro.)	0.02ms~300s			0.02ms~300s		
	T1&T2(Adv.)	0.05ms~300s			0.05ms~300s		
	Resolution	1μs			1μs		
	Accuracy	1μs+100ppm			1μs+100ppm		
	Slew Rate(Pro.)	2mA/μs~14.4A/μs	10mA/μs~36A/μs	20mA/μs~72A/μs	2mA/μs~14.4A/μs	10mA/μs~36A/μs	20mA/μs~72A/μs
	Slew Rate(Adv.)	2mA/μs~2.16A/μs	10mA/μs~10.8A/μs	20mA/μs~21.6A/μs	2mA/μs~2.16A/μs	10mA/μs~10.8A/μs	20mA/μs~21.6A/μs
	Min. Rise Time(Pro.)	10μs(Typical)			10μs(Typical)		
	Min. Rise Time(Adv.)	50μs(Typical)			50μs(Typical)		
	Resolution	2mA/μs	10mA/μs	20mA/μs	2mA/μs	10mA/μs	20mA/μs
	Accuracy	5%±10us			5%±10us		
Measurement							
Voltage	Range	0~16V	0~80V	0~200V	0~16V	0~80V	0~200V
	Resolution	0.1mV	0.5mV	2mV	0.1mV	0.5mV	2mV
	Accuracy	0.015%+0.015%F.S.			0.015%+0.015%F.S.		
Current	Range	0~216A	0~1080A	0~2160A	0~216A	0~1080A	0~2160A
	Resolution	2mA	10mA	20mA	2mA	10mA	20mA
	Accuracy	0.04%+0.04%F.S.			0.04%+0.04%F.S.		
Power	Range	0~1980W	0~9900W	0~19800W	0~2130W	0~10650W	0~21300W
	Resolution	100mW	500mW	1000mW	100mW	500mW	1000mW
	Accuracy	0.1%+0.1%F.S.			0.1%+0.1%F.S.		
Sampling Frequency	500kHz			500kHz			
Protection							
OVP	17.6V	88V	220V	17.6V	88V	220V	
OCP	220.32A	1101.6A	2203.2A	220.32A	1101.6A	2203.2A	
OPP	2039.4W	10197W	20394W	2193.9W	10969.5W	21939W	
Over Temperature	70-75°C			70-75°C			
Overvoltage Safety Value	110%V.F.S.			110%V.F.S.			
Reverse Alarm	Yes			Yes			
Alarm Tone	Yes			Yes			
Mechanical							
Dimensions(WxHxD)	423.0x444.0x670.0 mm			423.0x444.0x670.0 mm			
Package Dimensions(WxHxD)	544.0x741.0x891.0 mm			544.0x741.0x891.0 mm			
Unit Weight	105.5kg			109.5kg			
Shipping Weight	127.5kg			131.5kg			
AC Input							
Voltage	100~240Vac			100~240Vac			
Frequency	50~60Hz			50~60Hz			
Power	800VA			850VA			
Fuse	8A			8A			

EL Series High-density Programmable DC Electronic Load

MODEL		EL200VDC22000W			EL200VDC23500W		
Rated	Voltage	0~200V			0~200V		
	Current	0~2400A			0~2400A		
	Power	0~22000W			0~23500W		
	Min. Operating Voltage	0.18V@240A	0.9V@1200A	1.8V@2400A	0.18V@240A	0.9V@1200A	1.8V@2400A
Static Mode							
Constant Current Mode	Range	0~240A	0~1200A	0~2400A	0~240A	0~1200A	0~2400A
	Resolution	4mA	20mA	40mA	4mA	20mA	40mA
	Accuracy	0.05%+0.05%F.S.			0.05%+0.05%F.S.		
Constant Voltage Mode	Range	0~16V	0~80V	0~200V	0~16V	0~80V	0~200V
	Resolution	0.1mV	0.5mV	2mV	0.1mV	0.5mV	2mV
	Accuracy	0.025%+0.025%F.S.			0.025%+0.025%F.S.		
Constant Power Mode	Range	0~2200W	0~11000W	0~22000W	0~2350W	0~12750W	0~23500W
	Resolution	100mW	500mW	1000mW	100mW	500mW	1000mW
	Accuracy	0.2%+0.2%F.S.			0.2%+0.2%F.S.		
Constant Resistance Mode	Range	1.5mΩ~15Ω(16V)	6mΩ~60Ω(80V)	150mΩ~300Ω(200V)	1.5mΩ~15Ω(16V)	6mΩ~60Ω(80V)	150mΩ~300Ω(200V)
	Resolution	1.5mΩ(16V)	6mΩ(80V)	150mΩ(200V)	1.5mΩ(16V)	6mΩ(80V)	150mΩ(200V)
	Accuracy	Vin/Rset*(0.2%)+0.2% I.F.S.			Vin/Rset*(0.2%)+0.2% I.F.S.		
Dynamic Mode							
CCD/CRD	T1&T2(Pro.)	0.02ms~300s			0.02ms~300s		
	T1&T2(Adv.)	0.05ms~300s			0.05ms~300s		
	Resolution	1μs			1μs		
	Accuracy	1μs+100ppm			1μs+100ppm		
	Slew Rate(Pro.)	4mA/μs~16A/μs	20mA/μs~40A/μs	40mA/μs~80A/μs	4mA/μs~16A/μs	20mA/μs~40A/μs	40mA/μs~80A/μs
	Slew Rate(Adv.)	4mA/μs~2.4A/μs	20mA/μs~12A/μs	40mA/μs~24A/μs	4mA/μs~2.4A/μs	20mA/μs~12A/μs	40mA/μs~24A/μs
	Min. Rise Time(Pro.)	10μs(Typical)			10μs(Typical)		
	Min. Rise Time(Adv.)	50μs(Typical)			50μs(Typical)		
	Resolution	4mA/μs	20mA/μs	40mA/μs	4mA/μs	20mA/μs	40mA/μs
	Accuracy	5%±10us			5%±10us		
Measurement							
Voltage	Range	0~16V	0~80V	0~200V	0~16V	0~80V	0~200V
	Resolution	0.1mV	0.5mV	2mV	0.1mV	0.5mV	2mV
	Accuracy	0.015%+0.015%F.S.			0.015%+0.015%F.S.		
Current	Range	0~240A	0~1200A	0~2400A	0~240A	0~1200A	0~2400A
	Resolution	4mA	20mA	40mA	4mA	20mA	40mA
	Accuracy	0.04%+0.04%F.S.			0.04%+0.04%F.S.		
Power	Range	0~2200W	0~11000W	0~22000W	0~2350W	0~12750W	0~23500W
	Resolution	100mW	500mW	1000mW	100mW	500mW	1000mW
	Accuracy	0.1%+0.1%F.S.			0.1%+0.1%F.S.		
Sampling Frequency	500kHz			500kHz			
Protection							
OVP	17.6V	88V	220V	17.6V	88V	220V	
OCP	244.8A	1224A	2448A	244.8A	1224A	2448A	
OPP	2266W	11330W	22660W	2420.5W	12102.5W	24205W	
Over Temperature	70-75°C			70-75°C			
Overvoltage Safety Value	110%V.F.S.			110%V.F.S.			
Reverse Alarm	Yes			Yes			
Alarm Tone	Yes			Yes			
Mechanical							
Dimensions(WxHxD)	423.0x577.0x670.0 mm			423.0x577.0x670.0 mm			
Package Dimensions(WxHxD)	541.0x861.0x891.0 mm			541.0x861.0x891.0 mm			
Unit Weight	129kg			133kg			
Shipping Weight	153kg			157kg			
AC Input							
Voltage	100~240Vac			100~240Vac			
Frequency	50~60Hz			50~60Hz			
Power	950VA			1000VA			
Fuse	10A			10A			

EL Series High-density Programmable DC Electronic Load

MODEL		EL200VDC24200W			EL200VDC25700W		
Rated	Voltage	0~200V			0~200V		
	Current	0~2640A			0~2640A		
	Power	0~24200W			0~25700W		
	Min. Operating Voltage	0.18V@264A	0.9V@1320A	1.8V@2640A	0.18V@264A	0.9V@1320A	1.8V@2640A
Static Mode							
Constant Current Mode	Range	0~264A	0~1320A	0~2640A	0~264A	0~1320A	0~2640A
	Resolution	4mA	20mA	40mA	4mA	20mA	40mA
	Accuracy	0.05%+0.05%F.S.			0.05%+0.05%F.S.		
Constant Voltage Mode	Range	0~16V	0~80V	0~200V	0~16V	0~80V	0~200V
	Resolution	0.1mV	0.5mV	2mV	0.1mV	0.5mV	2mV
	Accuracy	0.025%+0.025%F.S.			0.025%+0.025%F.S.		
Constant Power Mode	Range	0~2420W	0~12100W	0~24200W	0~2570W	0~12850W	0~25700W
	Resolution	100mW	500mW	1000mW	100mW	500mW	1000mW
	Accuracy	0.2%+0.2%F.S.			0.2%+0.2%F.S.		
Constant Resistance Mode	Range	1.5mΩ~15Ω(16V)	6mΩ~60Ω(80V)	150mΩ~300Ω(200V)	1.5mΩ~15Ω(16V)	6mΩ~60Ω(80V)	150mΩ~300Ω(200V)
	Resolution	1.5mΩ(16V)	6mΩ(80V)	150mΩ(200V)	1.5mΩ(16V)	6mΩ(80V)	150mΩ(200V)
	Accuracy	Vin/Rset*(0.2%)+0.2% I.F.S.			Vin/Rset*(0.2%)+0.2% I.F.S.		
Dynamic Mode							
CCD/CRD	T1&T2(Pro.)	0.02ms~300s			0.02ms~300s		
	T1&T2(Adv.)	0.05ms~300s			0.05ms~300s		
	Resolution	1μs			1μs		
	Accuracy	1μs+100ppm			1μs+100ppm		
	Slew Rate(Pro.)	4mA/μs~17.6A/μs	20mA/μs~44A/μs	40mA/μs~88A/μs	4mA/μs~17.6A/μs	20mA/μs~44A/μs	40mA/μs~88A/μs
	Slew Rate(Adv.)	4mA/μs~2.64A/μs	20mA/μs~13.2A/μs	40mA/μs~26.4A/μs	4mA/μs~2.64A/μs	20mA/μs~13.2A/μs	40mA/μs~26.4A/μs
	Min. Rise Time(Pro.)	10μs(Typical)			10μs(Typical)		
	Min. Rise Time(Adv.)	50μs(Typical)			50μs(Typical)		
	Resolution	4mA/μs	20mA/μs	40mA/μs	4mA/μs	20mA/μs	40mA/μs
	Accuracy	5%±10us			5%±10us		
Measurement							
Voltage	Range	0~16V	0~80V	0~200V	0~16V	0~80V	0~200V
	Resolution	0.1mV	0.5mV	2mV	0.1mV	0.5mV	2mV
	Accuracy	0.015%+0.015%F.S.			0.015%+0.015%F.S.		
Current	Range	0~264A	0~1320A	0~2640A	0~264A	0~1320A	0~2640A
	Resolution	4mA	20mA	40mA	4mA	20mA	40mA
	Accuracy	0.04%+0.04%F.S.			0.04%+0.04%F.S.		
Power	Range	0~2420W	0~12100W	0~24200W	0~2570W	0~12850W	0~25700W
	Resolution	100mW	500mW	1000mW	100mW	500mW	1000mW
	Accuracy	0.1%+0.1%F.S.			0.1%+0.1%F.S.		
Sampling Frequency	500kHz			500kHz			
Protection							
OVP	17.6V	88V	220V	17.6V	88V	220V	
OCP	269.28A	1346.4A	2692.8A	269.28A	1346.4A	2692.8A	
OPP	2492.6W	12463W	24926W	2647.1W	13235.5W	26471W	
Over Temperature	70-75°C			70-75°C			
Overvoltage Safety Value	110%V.F.S.			110%V.F.S.			
Reverse Alarm	Yes			Yes			
Alarm Tone	Yes			Yes			
Mechanical							
Dimensions(WxHxD)	423.0x577.0x670.0 mm			423.0x577.0x670.0 mm			
Package Dimensions(WxHxD)	541.0x861.0x891.0 mm			541.0x861.0x891.0 mm			
Unit Weight	134.5kg			138.5kg			
Shipping Weight	158.5kg			162.5kg			
AC Input							
Voltage	100~240Vac			100~240Vac			
Frequency	50~60Hz			50~60Hz			
Power	1000VA			1050VA			
Fuse	10A			10A			

EL Series High-density Programmable DC Electronic Load

MODEL		EL200VDC26400W			EL200VDC27900W		
Rated	Voltage	0~200V			0~200V		
	Current	0~2880A			0~2880A		
	Power	0~26400W			0~27900W		
	Min. Operating Voltage	0.18V@288A	0.9V@1440A	1.8V@2880A	0.18V@288A	0.9V@1440A	1.8V@2880A
Static Mode							
Constant Current Mode	Range	0~288A	0~1440A	0~2880A	0~288A	0~1440A	0~2880A
	Resolution	4mA	20mA	40mA	4mA	20mA	40mA
	Accuracy	0.05%+0.05%F.S.			0.05%+0.05%F.S.		
Constant Voltage Mode	Range	0~16V	0~80V	0~200V	0~16V	0~80V	0~200V
	Resolution	0.1mV	0.5mV	2mV	0.1mV	0.5mV	2mV
	Accuracy	0.025%+0.025%F.S.			0.025%+0.025%F.S.		
Constant Power Mode	Range	0~2640W	0~13200W	0~26400W	0~2790W	0~13950W	0~27900W
	Resolution	100mW	500mW	1000mW	100mW	500mW	1000mW
	Accuracy	0.2%+0.2%F.S.			0.2%+0.2%F.S.		
Constant Resistance Mode	Range	1.3mΩ~12.5Ω(16V)	5mΩ~50Ω(80V)	125mΩ~250Ω(200V)	1.3mΩ~12.5Ω(16V)	5mΩ~50Ω(80V)	125mΩ~250Ω(200V)
	Resolution	1.3mΩ(16V)	5mΩ(80V)	125mΩ(200V)	1.3mΩ(16V)	5mΩ(80V)	125mΩ(200V)
	Accuracy	Vin/Rset*(0.2%)+0.2% I.F.S.			Vin/Rset*(0.2%)+0.2% I.F.S.		
Dynamic Mode							
CCD/CRD	T1&T2(Pro.)	0.02ms~300s			0.02ms~300s		
	T1&T2(Adv.)	0.05ms~300s			0.05ms~300s		
	Resolution	1μs			1μs		
	Accuracy	1μs+100ppm			1μs+100ppm		
	Slew Rate(Pro.)	4mA/μs~19.2A/μs	20mA/μs~48A/μs	40mA/μs~96A/μs	4mA/μs~19.2A/μs	20mA/μs~48A/μs	40mA/μs~96A/μs
	Slew Rate(Adv.)	4mA/μs~2.88A/μs	20mA/μs~14.4A/μs	40mA/μs~28.8A/μs	4mA/μs~2.88A/μs	20mA/μs~14.4A/μs	40mA/μs~28.8A/μs
	Min. Rise Time(Pro.)	10μs(Typical)			10μs(Typical)		
	Min. Rise Time(Adv.)	50μs(Typical)			50μs(Typical)		
	Resolution	4mA/μs	20mA/μs	40mA/μs	4mA/μs	20mA/μs	40mA/μs
	Accuracy	5%±10us			5%±10us		
Measurement							
Voltage	Range	0~16V	0~80V	0~200V	0~16V	0~80V	0~200V
	Resolution	0.1mV	0.5mV	2mV	0.1mV	0.5mV	2mV
	Accuracy	0.015%+0.015%F.S.			0.015%+0.015%F.S.		
Current	Range	0~288A	0~1440A	0~2880A	0~288A	0~1440A	0~2880A
	Resolution	4mA	20mA	40mA	4mA	20mA	40mA
	Accuracy	0.04%+0.04%F.S.			0.04%+0.04%F.S.		
Power	Range	0~2640W	0~13200W	0~26400W	0~2790W	0~13950W	0~27900W
	Resolution	100mW	500mW	1000mW	100mW	500mW	1000mW
	Accuracy	0.1%+0.1%F.S.			0.1%+0.1%F.S.		
Sampling Frequency	500kHz			500kHz			
Protection							
OVP	17.6V	88V	220V	17.6V	88V	220V	
OCP	293.76A	1468.8A	2937.6A	293.76A	1468.8A	2937.6A	
OPP	2719.2W	13596W	27192W	2873.7W	14368.5W	28737W	
Over Temperature	70-75°C			70-75°C			
Overvoltage Safety Value	110%V.F.S.			110%V.F.S.			
Reverse Alarm	Yes			Yes			
Alarm Tone	Yes			Yes			
Mechanical							
Dimensions(WxHxD)	423.0x577.0x670.0 mm			423.0x577.0x670.0 mm			
Package Dimensions(WxHxD)	541.0x861.0x891.0 mm			541.0x861.0x891.0 mm			
Unit Weight	140kg			144kg			
Shipping Weight	164kg			168kg			
AC Input							
Voltage	100~240Vac			100~240Vac			
Frequency	50~60Hz			50~60Hz			
Power	1050VA			1100VA			
Fuse	10A			10A			

EL Series High-density Programmable DC Electronic Load

200V Series System Specifications			
Non Linear Mode			
Range	CL	30uF~5000uF	
	RL	As CR Mode	
	Ls	0.1uH~16uH	
	Rs	30mΩ~20Ω	
Resolution	CL	1uF	
	RL	As CR Mode	
	Ls	0.1uH	
	Rs	1mΩ	
Battery Discharge Mode			
Battery Voltage	As CV Mode		
Current Resolution	As CC Mode		
Record	AH/WH		
Test Time	1s~100000s		
Time Resolution	1s		
Program Mode			
Step No.	300 Max.		
Dwell	0.1ms~4000s		
Spec Check	Voltage/Current/Power		
External Waveform Control/Monitor			
Control/Monitor	Voltage/Current		
Input/Output Range	0~10V		
Voltage Range	0~L_range F.S.	0~M_range F.S.	0~H_range F.S.
Current Range	0~L_range F.S.	0~M_range F.S.	0~H_range F.S.
Accuracy	0.4%F.S.		
Resolution	4mV		
Bandwidth	20kHz		
Input Impedance	10kΩ		
Short Circuit			
Current(CC)	Full range current value		
Voltage(CV)	Voltage value at the Max power in working mode		
Resistance(CR)	Min resistance value of CR Mode		
Master/Slave			
Parallel Interface	RJ45		
Parallel Quantity (Pro.)	20 units		
Parallel Quantity (Adv.)	20 units		
General			
Graphic Display	4.3" Color touch LCD		
Operation Key Feature	Soft key, Numeric key, Rotary Knob, USB port for transfer and upgrading firmware		
Rack Mount Handles	Yes		
FAN	Temperature Control		
Interface	RS232/RS485/USB(Standard), GPIB/LAN(Optional)		
Communication Response Time	30ms		
Storage Capacity	User defined settings (300 sets), OCP settings (10 sets), OPP settings (10 sets), Default settings (1 set), Factory setting (1 set)		
Environmental			
Operating Temperature	0~40°C		
Storage Temperature	-20~80°C		
Temperature Coefficient	100ppm/°C(Typical)		
Relative Humidity	10~90%RH		
Altitude	<2000m		
Regulatory Compliance			
Overvoltage Category	II		
Protection Degree	I		
Pollution Degree	II		
Input Impedance	800kΩ(Typical)		
Isolation Voltage	/		
Certificates	CE		

All specifications are subject to change without notice.

EL Series High-density Programmable DC Electronic Load

MODEL		EL600VDC600W			EL600VDC1200W		
Rated	Voltage	0~600V			0~600V		
	Current	0~40A			0~90A		
	Power	0~600W			0~1200W		
	Min. Operating Voltage	0.8V@4A	0.9V@20A	1.8V@40A	0.8V@9A	4V@45A	8V@90A
Static Mode							
Constant Current Mode	Range	0~4A	0~20A	0~40A	0~9A	0~45A	0~90A
	Resolution	0.1mA	0.5mA	1mA	0.1mA	0.5mA	1mA
	Accuracy	0.05%+0.05%F.S.			0.05%+0.05%F.S.		
Constant Voltage Mode	Range	0~80V	0~150V	0~600V	0~80V	0~150V	0~600V
	Resolution	0.5mV	1mV	5mV	0.5mV	1mV	5mV
	Accuracy	0.025%+0.025%F.S.			0.025%+0.025%F.S.		
Constant Power Mode	Range	0~60W	0~300W	0~600W	0~120W	0~600W	0~1200W
	Resolution	1mW	5mW	10mW	2mW	10mW	20mW
	Accuracy	0.2%+0.2%F.S.			0.2%+0.2%F.S.		
Constant Resistance Mode	Range	400mΩ~4000Ω(80V)	1600mΩ~16000Ω(150V)	16000mΩ~32000Ω(600V)	275mΩ~2750Ω(80V)	1100mΩ~11000Ω(150V)	11000mΩ~22000Ω(600V)
	Resolution	400mΩ(80V)	1600mΩ(150V)	16000mΩ(600V)	275mΩ(80V)	1100mΩ(150V)	11000mΩ(600V)
	Accuracy	Vin/Rset*(0.2%)+0.2% I.F.S.			Vin/Rset*(0.2%)+0.2% I.F.S.		
Dynamic Mode							
CCD/CRD	T1&T2(Pro.)	0.02ms~300s			0.02ms~300s		
	T1&T2(Adv.)	0.05ms~300s			0.05ms~300s		
	Resolution	1μs			1μs		
	Accuracy	1μs+100ppm			1μs+100ppm		
	Slew Rate(Pro.)	0.1mA/μs~0.18A/μs	0.5mA/μs~0.9A/μs	1mA/μs~1.8A/μs	0.1mA/μs~0.36A/μs	0.5mA/μs~1.8A/μs	1mA/μs~3.6A/μs
	Slew Rate(Adv.)	0.1mA/μs~0.04A/μs	0.5mA/μs~0.2A/μs	1mA/μs~0.4A/μs	0.1mA/μs~0.09A/μs	0.5mA/μs~0.45A/μs	1mA/μs~0.9A/μs
	Min. Rise Time(Pro.)	20μs(Typical)			20μs(Typical)		
	Min. Rise Time(Adv.)	50μs(Typical)			50μs(Typical)		
	Resolution	0.1mA/μs	0.5mA/μs	1mA/μs	0.1mA/μs	0.5mA/μs	1mA/μs
	Accuracy	5%±10us			5%±10us		
Measurement							
Voltage	Range	0~80V	0~150V	0~600V	0~80V	0~150V	0~600V
	Resolution	0.5mV	1mV	5mV	0.5mV	1mV	5mV
	Accuracy	0.015%+0.015%F.S.			0.015%+0.015%F.S.		
Current	Range	0~4A	0~20A	0~40A	0~9A	0~45A	0~90A
	Resolution	0.1mA	0.5mA	1mA	0.1mA	0.5mA	1mA
	Accuracy	0.04%+0.04%F.S.			0.04%+0.04%F.S.		
Power	Range	0~60W	0~300W	0~600W	0~120W	0~600W	0~1200W
	Resolution	1mW	5mW	10mW	2mW	10mW	20mW
	Accuracy	0.1%+0.1%F.S.			0.1%+0.1%F.S.		
Sampling Frequency	500kHz			500kHz			
Protection							
OVP	88V	165V	660V	88V	165V	660V	
OCP	4.08A	20.4A	40.8A	9.18A	45.9A	91.8A	
OPP	61.8W	309W	618W	123.6W	618W	1236W	
Over Temperature	70-75°C			70-75°C			
Overvoltage Safety Value	110%V.F.S.			110%V.F.S.			
Reverse Alarm	Yes			Yes			
Alarm Tone	Yes			Yes			
Mechanical							
Dimensions(WxHxD)	423.0x88.0x610.0mm			423.0x88.0x610.0 mm			
Package Dimensions(WxHxD)	665.0x333.0x918.0mm			665.0x333.0x918.0 mm			
Unit Weight	18kg			20kg			
Shipping Weight	27kg			29kg			
AC Input							
Voltage	100~240Vac			100~240Vac			
Frequency	50~60Hz			50~60Hz			
Power	100VA			125VA			
Fuse	2.5A			2.5A			

EL Series High-density Programmable DC Electronic Load

MODEL		EL600VDC1800W			EL600VDC2400W		
Rated	Voltage	0~600V			0~600V		
	Current	0~130A			0~180A		
	Power	0~1800W			0~2400W		
	Min. Operating Voltage	0.8V@13A	4V@65A	8V@130A	0.8V@18A	4V@90A	8V@180A
Static Mode							
Constant Current Mode	Range	0~13A	0~65A	0~130A	0~18A	0~90A	0~180A
	Resolution	0.1mA	0.5mA	1mA	0.2mA	1mA	2mA
	Accuracy	0.05%+0.05%F.S.			0.05%+0.05%F.S.		
Constant Voltage Mode	Range	0~80V	0~150V	0~600V	0~80V	0~150V	0~600V
	Resolution	0.5mV	1mV	5mV	0.5mV	1mV	5mV
	Accuracy	0.025%+0.025%F.S.			0.025%+0.025%F.S.		
Constant Power Mode	Range	0~180W	0~900W	0~1800W	0~240W	0~1200W	0~2400W
	Resolution	2mW	10mW	20mW	5mW	25mW	50mW
	Accuracy	0.2%+0.2%F.S.			0.2%+0.2%F.S.		
Constant Resistance Mode	Range	200mΩ~2000Ω(80V)	800mΩ~8000Ω(150V)	8000mΩ~16000Ω(600V)	137.5mΩ~1375Ω(80V)	550mΩ~5500Ω(150V)	5500mΩ~11000Ω(600V)
	Resolution	200mΩ(80V)	800mΩ(150V)	8000mΩ(600V)	137.5mΩ(80V)	550mΩ(150V)	5500mΩ(600V)
	Accuracy	Vin/Rset*(0.2%)+0.2% I.F.S.			Vin/Rset*(0.2%)+0.2% I.F.S.		
Dynamic Mode							
CCD/CRD	T1&T2(Pro.)	0.02ms~300s			0.02ms~300s		
	T1&T2(Adv.)	0.05ms~300s			0.05ms~300s		
	Resolution	1μs			1μs		
	Accuracy	1μs+100ppm			1μs+100ppm		
	Slew Rate(Pro.)	0.1mA/μs~0.6A/μs	0.5mA/μs~3A/μs	1mA/μs~6A/μs	0.2mA/μs~0.72A/μs	1mA/μs~3.6A/μs	2mA/μs~7.2A/μs
	Slew Rate(Adv.)	0.1mA/μs~0.13A/μs	0.5mA/μs~0.65A/μs	1mA/μs~1.3A/μs	0.2mA/μs~0.18A/μs	1mA/μs~0.9A/μs	2mA/μs~1.8A/μs
	Min. Rise Time(Pro.)	20μs(Typical)			20μs(Typical)		
	Min. Rise Time(Adv.)	50μs(Typical)			50μs(Typical)		
	Resolution	0.1mA/μs	0.5mA/μs	1mA/μs	0.2mA/μs	1mA/μs	2mA/μs
	Accuracy	5%±10us			5%±10us		
Measurement							
Voltage	Range	0~80V	0~150V	0~600V	0~80V	0~150V	0~600V
	Resolution	0.5mV	1mV	5mV	0.5mV	1mV	5mV
	Accuracy	0.015%+0.015%F.S.			0.015%+0.015%F.S.		
Current	Range	0~13A	0~65A	0~130A	0~18A	0~90A	0~180A
	Resolution	0.1mA	0.5mA	1mA	0.2mA	1mA	2mA
	Accuracy	0.04%+0.04%F.S.			0.04%+0.04%F.S.		
Power	Range	0~180W	0~900W	0~1800W	0~240W	0~1200W	0~2400W
	Resolution	2mW	10mW	20mW	5mW	25mW	50mW
	Accuracy	0.1%+0.1%F.S.			0.1%+0.1%F.S.		
Sampling Frequency	500kHz			500kHz			
Protection							
OVP	88V	165V	660V	88V	165V	660V	
OCP	13.26A	66.3A	132.6A	18.36A	91.8A	183.6A	
OPP	185.4W	927W	1854W	247.2W	1236W	2472W	
Over Temperature	70-75°C			70-75°C			
Overvoltage Safety Value	110%V.F.S.			110%V.F.S.			
Reverse Alarm	Yes			Yes			
Alarm Tone	Yes			Yes			
Mechanical							
Dimensions(WxHxD)	423.0x88.0x610.0 mm			423.0x88.0x610.0 mm			
Package Dimensions(WxHxD)	665.0x333.0x918.0 mm			665.0x333.0x918.0 mm			
Unit Weight	22kg			24kg			
Shipping Weight	31kg			33kg			
AC Input							
Voltage	100~240Vac			100~240Vac			
Frequency	50~60Hz			50~60Hz			
Power	125VA			150VA			
Fuse	2.5A			2.5A			

EL Series High-density Programmable DC Electronic Load

MODEL		EL600VDC3000W			EL600VDC3400W		
Rated	Voltage	0~600V			0~600V		
	Current	0~220A			0~250A		
	Power	0~3000W			0~3400W		
	Min. Operating Voltage	0.8V@22A	4V@110A	8V@220A	0.8V@25A	4V@125A	8V@250A
Static Mode							
Constant Current Mode	Range	0~22A	0~110A	0~220A	0~25A	0~125A	0~250A
	Resolution	0.2mA	1mA	2mA	0.4mA	2mA	4mA
	Accuracy	0.05%+0.05%F.S.			0.05%+0.05%F.S.		
Constant Voltage Mode	Range	0~80V	0~150V	0~600V	0~80V	0~150V	0~600V
	Resolution	0.5mV	1mV	5mV	0.5mV	1mV	5mV
	Accuracy	0.025%+0.025%F.S.			0.025%+0.025%F.S.		
Constant Power Mode	Range	0~300W	0~1500W	0~3000W	0~340W	0~1700W	0~3400W
	Resolution	5mW	25mW	50mW	10mW	50mW	100mW
	Accuracy	0.2%+0.2%F.S.			0.2%+0.2%F.S.		
Constant Resistance Mode	Range	110mΩ~1100Ω(80V)	440mΩ~4400Ω(150V)	4400mΩ~8800Ω(600V)	100mΩ~1000Ω(80V)	400mΩ~4000Ω(150V)	4000mΩ~8000Ω(600V)
	Resolution	110mΩ(80V)	440mΩ(150V)	4400mΩ(600V)	100mΩ(80V)	400mΩ(150V)	4000mΩ(600V)
	Accuracy	Vin/Rset*(0.2%)+0.2% I.F.S.			Vin/Rset*(0.2%)+0.2% I.F.S.		
Dynamic Mode							
CCD/CRD	T1&T2(Pro.)	0.02ms~300s			0.02ms~300s		
	T1&T2(Adv.)	0.05ms~300s			0.05ms~300s		
	Resolution	1μs			1μs		
	Accuracy	1μs+100ppm			1μs+100ppm		
	Slew Rate(Pro.)	0.2mA/μs~0.9A/μs	1mA/μs~4.5A/μs	2mA/μs~9A/μs	0.4mA/μs~1A/μs	2mA/μs~5A/μs	4mA/μs~10A/μs
	Slew Rate(Adv.)	0.2mA/μs~0.22A/μs	1mA/μs~1.1A/μs	2mA/μs~2.2A/μs	0.4mA/μs~0.25A/μs	2mA/μs~1.25A/μs	4mA/μs~2.5A/μs
	Min. Rise Time(Pro.)	20μs(Typical)			20μs(Typical)		
	Min. Rise Time(Adv.)	50μs(Typical)			50μs(Typical)		
	Resolution	0.2mA/μs	1mA/μs	2mA/μs	0.4mA/μs	2mA/μs	4mA/μs
	Accuracy	5%±10us			5%±10us		
Measurement							
Voltage	Range	0~80V	0~150V	0~600V	0~80V	0~150V	0~600V
	Resolution	0.5mV	1mV	5mV	0.5mV	1mV	5mV
	Accuracy	0.015%+0.015%F.S.			0.015%+0.015%F.S.		
Current	Range	0~22A	0~110A	0~220A	0~25A	0~125A	0~250A
	Resolution	0.2mA	1mA	2mA	0.4mA	2mA	4mA
	Accuracy	0.04%+0.04%F.S.			0.04%+0.04%F.S.		
Power	Range	0~300W	0~1500W	0~3000W	0~340W	0~1700W	0~3400W
	Resolution	5mW	25mW	50mW	10mW	50mW	100mW
	Accuracy	0.1%+0.1%F.S.			0.1%+0.1%F.S.		
Sampling Frequency	500kHz			500kHz			
Protection							
OVP	88V	165V	660V	88V	165V	660V	
OCP	22.44A	112.2A	224.4A	25.5A	127.5A	255A	
OPP	309W	1545W	3090W	350.2W	1751W	3502W	
Over Temperature	70-75°C			70-75°C			
Overvoltage Safety Value	110%V.F.S.			110%V.F.S.			
Reverse Alarm	Yes			Yes			
Alarm Tone	Yes			Yes			
Mechanical							
Dimensions(WxHxD)	423.0x88.0x610.0 mm			423.0x133.0x610.0 mm			
Package Dimensions(WxHxD)	665.0x333.0x918.0 mm			665.0x348.0x918.0 mm			
Unit Weight	26kg			27kg			
Shipping Weight	35kg			36kg			
AC Input							
Voltage	100~240Vac			100~240Vac			
Frequency	50~60Hz			50~60Hz			
Power	180VA			225VA			
Fuse	2.5A			2.5A			

EL Series High-density Programmable DC Electronic Load

MODEL		EL600VDC4400W			EL600VDC5600W		
Rated	Voltage	0~600V			0~600V		
	Current	0~320A			0~410A		
	Power	0~4400W			0~5600W		
	Min. Operating Voltage	0.8V@32A	4V@160A	8V@320A	0.8V@41A	4V@205A	8V@410A
Static Mode							
Constant Current Mode	Range	0~32A	0~160A	0~320A	0~41A	0~205A	0~410A
	Resolution	0.4mA	2mA	4mA	0.4mA	2mA	4mA
	Accuracy	0.05%+0.05%F.S.			0.05%+0.05%F.S.		
Constant Voltage Mode	Range	0~80V	0~150V	0~600V	0~80V	0~150V	0~600V
	Resolution	0.5mV	1mV	5mV	0.5mV	1mV	5mV
	Accuracy	0.025%+0.025%F.S.			0.025%+0.025%F.S.		
Constant Power Mode	Range	0~440W	0~2200W	0~4400W	0~560W	0~2800W	0~5600W
	Resolution	10mW	50mW	100mW	10mW	50mW	100mW
	Accuracy	0.2%+0.2%F.S.			0.2%+0.2%F.S.		
Constant Resistance Mode	Range	75mΩ~750Ω(80V)	300mΩ~3000Ω(150V)	3000mΩ~6000Ω(600V)	60mΩ~600Ω(80V)	250mΩ~2500Ω(150V)	2500mΩ~5000Ω(600V)
	Resolution	75mΩ(80V)	300mΩ(150V)	3000mΩ(600V)	60mΩ(80V)	250mΩ(150V)	2500mΩ(600V)
	Accuracy	Vin/Rset*(0.2%)+0.2% I.F.S.			Vin/Rset*(0.2%)+0.2% I.F.S.		
Dynamic Mode							
CCD/CRD	T1&T2(Pro.)	0.02ms~300s			0.02ms~300s		
	T1&T2(Adv.)	0.05ms~300s			0.05ms~300s		
	Resolution	1μs			1μs		
	Accuracy	1μs+100ppm			1μs+100ppm		
	Slew Rate(Pro.)	0.4mA/μs~1.28A/μs	2mA/μs~6.4A/μs	4mA/μs~12.8A/μs	0.4mA/μs~1.64A/μs	2mA/μs~8.2A/μs	4mA/μs~16.4A/μs
	Slew Rate(Adv.)	0.4mA/μs~0.32A/μs	2mA/μs~1.6A/μs	4mA/μs~3.2A/μs	0.4mA/μs~0.41A/μs	2mA/μs~2.05A/μs	4mA/μs~4.1A/μs
	Min. Rise Time(Pro.)	20μs(Typical)			20μs(Typical)		
	Min. Rise Time(Adv.)	50μs(Typical)			50μs(Typical)		
	Resolution	0.4mA/μs	2mA/μs	4mA/μs	0.4mA/μs	2mA/μs	4mA/μs
Accuracy	5%±10us			5%±10us			
Measurement							
Voltage	Range	0~80V	0~150V	0~600V	0~80V	0~150V	0~600V
	Resolution	0.5mV	1mV	5mV	0.5mV	1mV	5mV
	Accuracy	0.015%+0.015%F.S.			0.015%+0.015%F.S.		
Current	Range	0~32A	0~160A	0~320A	0~41A	0~205A	0~410A
	Resolution	0.4mA	2mA	4mA	0.4mA	2mA	4mA
	Accuracy	0.04%+0.04%F.S.			0.04%+0.04%F.S.		
Power	Range	0~440W	0~2200W	0~4400W	0~560W	0~2800W	0~5600W
	Resolution	10mW	50mW	100mW	10mW	50mW	100mW
	Accuracy	0.1%+0.1%F.S.			0.1%+0.1%F.S.		
Sampling Frequency	500kHz			500kHz			
Protection							
OVP	88V	165V	660V	88V	165V	660V	
OCP	32.6A	163.2A	326.4A	41.82A	209.1A	418.2A	
OPP	453.2W	2266W	4532W	576.8W	2884W	5768W	
Over Temperature	70-75°C			70-75°C			
Overvoltage Safety Value	110%V.F.S.			110%V.F.S.			
Reverse Alarm	Yes			Yes			
Alarm Tone	Yes			Yes			
Mechanical							
Dimensions(WxHxD)	423.0x133.0x610.0 mm			423.0x133.0x610.0 mm			
Package Dimensions(WxHxD)	665.0x348.0x918.0 mm			665.0x348.0x918.0 mm			
Unit Weight	28.5kg			32.5kg			
Shipping Weight	37.5kg			41.5kg			
AC Input							
Voltage	100~240Vac			100~240Vac			
Frequency	50~60Hz			50~60Hz			
Power	250VA			250VA			
Fuse	2.5A			2.5A			

EL Series High-density Programmable DC Electronic Load

MODEL		EL600VDC6600W			EL600VDC8100W		
Rated	Voltage	0~600V			0~600V		
	Current	0~480A			0~600A		
	Power	0~6600W			0~8100W		
	Min. Operating Voltage	0.8V@48A	4V@240A	8V@480A	0.8V@60A	4V@300A	8V@600A
Static Mode							
Constant Current Mode	Range	0~48A	0~240A	0~480A	0~60A	0~300A	0~600A
	Resolution	0.5mA	2mA	5mA	0.5mA	2mA	5mA
	Accuracy	0.05%+0.05%F.S.			0.05%+0.05%F.S.		
Constant Voltage Mode	Range	0~80V	0~150V	0~600V	0~80V	0~150V	0~600V
	Resolution	0.5mV	1mV	5mV	0.5mV	1mV	5mV
	Accuracy	0.025%+0.025%F.S.			0.025%+0.025%F.S.		
Constant Power Mode	Range	0~660W	0~3300W	0~6600W	0~810W	0~4050W	0~8100W
	Resolution	10mW	50mW	100mW	10mW	50mW	100mW
	Accuracy	0.2%+0.2%F.S.			0.2%+0.2%F.S.		
Constant Resistance Mode	Range	50mΩ~500Ω(80V)	200mΩ~2000Ω(150V)	2000mΩ~4000Ω(600V)	50mΩ~500Ω(80V)	200mΩ~2000Ω(150V)	2000mΩ~4000Ω(600V)
	Resolution	50mΩ(80V)	200mΩ(150V)	2000mΩ(600V)	50mΩ(80V)	200mΩ(150V)	2000mΩ(600V)
	Accuracy	Vin/Rset*(0.2%)+0.2% I.F.S.			Vin/Rset*(0.2%)+0.2% I.F.S.		
Dynamic Mode							
CCD/CRD	T1&T2(Pro.)	0.02ms~300s			0.02ms~300s		
	T1&T2(Adv.)	0.05ms~300s			0.05ms~300s		
	Resolution	1μs			1μs		
	Accuracy	1μs+100ppm			1μs+100ppm		
	Slew Rate(Pro.)	0.5mA/μs~1.92A/μs	2mA/μs~9.6A/μs	5mA/μs~19.2A/μs	0.5mA/μs~1.92A/μs	2mA/μs~9.6A/μs	5mA/μs~19.2A/μs
	Slew Rate(Adv.)	0.5mA/μs~0.48A/μs	2mA/μs~2.4A/μs	5mA/μs~4.8A/μs	0.5mA/μs~0.6A/μs	2mA/μs~3A/μs	5mA/μs~6A/μs
	Min. Rise Time(Pro.)	20μs(Typical)			20μs(Typical)		
	Min. Rise Time(Adv.)	50μs(Typical)			50μs(Typical)		
	Resolution	0.5mA/μs	2mA/μs	5mA/μs	0.5mA/μs	2mA/μs	5mA/μs
	Accuracy	5%±10us			5%±10us		
Measurement							
Voltage	Range	0~80V	0~150V	0~600V	0~80V	0~150V	0~600V
	Resolution	0.5mV	1mV	5mV	0.5mV	1mV	5mV
	Accuracy	0.015%+0.015%F.S.			0.015%+0.015%F.S.		
Current	Range	0~48A	0~240A	0~480A	0~60A	0~300A	0~300A
	Resolution	0.5mA	2mA	5mA	0.5mA	2mA	5mA
	Accuracy	0.04%+0.04%F.S.			0.04%+0.04%F.S.		
Power	Range	0~660W	0~3300W	0~6600W	0~810W	0~810W	0~8100W
	Resolution	10mW	50mW	100mW	10mW	50mW	100mW
	Accuracy	0.1%+0.1%F.S.			0.1%+0.1%F.S.		
Sampling Frequency	500kHz			500kHz			
Protection							
OVP	88V	165V	660V	88V	165V	660V	
OCP	48.96A	244.8A	489.6A	61.2A	306A	612A	
OPP	679.8W	3399W	6798W	834.3W	4171.5W	8343W	
Over Temperature	70-75°C			70-75°C			
Overvoltage Safety Value	110%V.F.S.			110%V.F.S.			
Reverse Alarm	Yes			Yes			
Alarm Tone	Yes			Yes			
Mechanical							
Dimensions(WxHxD)	423.0x177.0x610.0 mm			423.0x177.0x610.0 mm			
Package Dimensions(WxHxD)	665.0x392.0x918.0 mm			665.0x392.0x918.0 mm			
Unit Weight	38kg			42kg			
Shipping Weight	47kg			51kg			
AC Input							
Voltage	100~240Vac			100~240Vac			
Frequency	50~60Hz			50~60Hz			
Power	300VA			350VA			
Fuse	3.15A			3.15A			

EL Series High-density Programmable DC Electronic Load

MODEL		EL600VDC8800W			EL600VDC10300W		
Rated	Voltage	0~600V			0~600V		
	Current	0~640A			0~760A		
	Power	0~8800W			0~10300W		
	Min. Operating Voltage	0.8V@64A	4V@320A	8V@640A	0.8V@76A	4V@380A	8V@760A
Static Mode							
Constant Current Mode	Range	0~64A	0~320A	0~640A	0~76A	0~380A	0~760A
	Resolution	0.5mA	2mA	5mA	0.5mA	2mA	5mA
	Accuracy	0.05%+0.05%F.S.			0.05%+0.05%F.S.		
Constant Voltage Mode	Range	0~80V	0~150V	0~600V	0~80V	0~150V	0~600V
	Resolution	0.5mV	1mV	5mV	0.5mV	1mV	5mV
	Accuracy	0.025%+0.025%F.S.			0.025%+0.025%F.S.		
Constant Power Mode	Range	0~880W	0~4400W	0~8800W	0~1030W	0~5150W	0~10300W
	Resolution	20mW	100mW	200mW	20mW	100mW	200mW
	Accuracy	0.2%+0.2%F.S.			0.2%+0.2%F.S.		
Constant Resistance Mode	Range	37.5mΩ~375Ω(80V)	150mΩ~1500Ω(150V)	1500mΩ~3000Ω(600V)	37.5mΩ~375Ω(80V)	150mΩ~1500Ω(150V)	1500mΩ~3000Ω(600V)
	Resolution	37.5mΩ(80V)	150mΩ(150V)	1500mΩ(600V)	37.5mΩ(80V)	150mΩ(150V)	1500mΩ(600V)
	Accuracy	Vin/Rset*(0.2%)+0.2% I.F.S.			Vin/Rset*(0.2%)+0.2% I.F.S.		
Dynamic Mode							
CCD/CRD	T1&T2(Pro.)	0.02ms~300s			0.02ms~300s		
	T1&T2(Adv.)	0.05ms~300s			0.05ms~300s		
	Resolution	1μs			1μs		
	Accuracy	1μs+100ppm			1μs+100ppm		
	Slew Rate(Pro.)	0.5mA/μs~2A/μs	2mA/μs~10A/μs	5mA/μs~20A/μs	0.5mA/μs~2A/μs	2mA/μs~10A/μs	5mA/μs~20A/μs
	Slew Rate(Adv.)	0.5mA/μs~0.64A/μs	2mA/μs~3.2A/μs	5mA/μs~6.4A/μs	0.5mA/μs~0.76A/μs	2mA/μs~3.8A/μs	5mA/μs~7.6A/μs
	Min. Rise Time(Pro.)	20μs(Typical)			20μs(Typical)		
	Min. Rise Time(Adv.)	50μs(Typical)			50μs(Typical)		
	Resolution	0.5mA/μs	2mA/μs	5mA/μs	0.5mA/μs	2mA/μs	5mA/μs
	Accuracy	5%±10us			5%±10us		
Measurement							
Voltage	Range	0~80V	0~150V	0~600V	0~80V	0~150V	0~600V
	Resolution	0.5mV	1mV	5mV	0.5mV	1mV	5mV
	Accuracy	0.015%+0.015%F.S.			0.015%+0.015%F.S.		
Current	Range	0~64A	0~320A	0~640A	0~76A	0~380A	0~760A
	Resolution	0.5mA	2mA	5mA	0.5mA	2mA	5mA
	Accuracy	0.04%+0.04%F.S.			0.04%+0.04%F.S.		
Power	Range	0~880W	0~4400W	0~8800W	0~1030W	0~5150W	0~10300W
	Resolution	20mW	100mW	200mW	20mW	100mW	200mW
	Accuracy	0.1%+0.1%F.S.			0.1%+0.1%F.S.		
Sampling Frequency	500kHz			500kHz			
Protection							
OVP	88V	165V	660V	88V	165V	660V	
OCP	65.28A	326.4A	652.8A	77.52A	387.6A	775.2A	
OPP	906.4W	4532W	9064W	1060.9W	1060.9W	10609W	
Over Temperature	70-75°C			70-75°C			
Overvoltage Safety Value	110%V.F.S.			110%V.F.S.			
Reverse Alarm	Yes			Yes			
Alarm Tone	Yes			Yes			
Mechanical							
Dimensions(WxHxD)	423.0x311.0x670.0 mm			423.0x311.0x670.0 mm			
Package Dimensions(WxHxD)	541.0x591.0x891.0 mm			541.0x591.0x891.0 mm			
Unit Weight	61.5kg			65.5kg			
Shipping Weight	81.5kg			85.5kg			
AC Input							
Voltage	100~240Vac			100~240Vac			
Frequency	50~60Hz			50~60Hz			
Power	450VA			500VA			
Fuse	5A			5A			

EL Series High-density Programmable DC Electronic Load

MODEL		EL600VDC11000W			EL600VDC12500W		
Rated	Voltage	0~600V			0~600V		
	Current	0~800A			0~920A		
	Power	0~11000W			0~12500W		
	Min. Operating Voltage	0.8V@80A	4V@400A	8V@800A	0.8V@92A	4V@460A	8V@920A
Static Mode							
Constant Current Mode	Range	0~80A	0~400A	0~800A	0~92A	0~460A	0~920A
	Resolution	1mA	5mA	10mA	1mA	5mA	10mA
	Accuracy	0.05%+0.05%F.S.			0.05%+0.05%F.S.		
Constant Voltage Mode	Range	0~80V	0~150V	0~600V	0~80V	0~150V	0~600V
	Resolution	0.5mV	1mV	5mV	0.5mV	1mV	5mV
	Accuracy	0.025%+0.025%F.S.			0.025%+0.025%F.S.		
Constant Power Mode	Range	0~1100W	0~5500W	0~11000W	0~1250W	0~6250W	0~12500W
	Resolution	20mW	100mW	200mW	20mW	100mW	200mW
	Accuracy	0.2%+0.2%F.S.			0.2%+0.2%F.S.		
Constant Resistance Mode	Range	30mΩ~300Ω(80V)	120mΩ~1200Ω(150V)	1200mΩ~2400Ω(600V)	30mΩ~300Ω(80V)	120mΩ~1200Ω(150V)	1200mΩ~2400Ω(600V)
	Resolution	30mΩ(80V)	120mΩ(150V)	1200mΩ(600V)	30mΩ(80V)	120mΩ(150V)	1200mΩ(600V)
	Accuracy	Vin/Rset*(0.2%)+0.2% I.F.S.			Vin/Rset*(0.2%)+0.2% I.F.S.		
Dynamic Mode							
CCD/CRD	T1&T2(Pro.)	0.02ms~300s			0.02ms~300s		
	T1&T2(Adv.)	0.05ms~300s			0.05ms~300s		
	Resolution	1μs			1μs		
	Accuracy	1μs+100ppm			1μs+100ppm		
	Slew Rate(Pro.)	1mA/μs~2.5A/μs	5mA/μs~12.5A/μs	10mA/μs~25A/μs	1mA/μs~2.5A/μs	5mA/μs~12.5A/μs	10mA/μs~25A/μs
	Slew Rate(Adv.)	1mA/μs~0.8A/μs	5mA/μs~4A/μs	10mA/μs~8A/μs	1mA/μs~0.92A/μs	5mA/μs~4.6A/μs	10mA/μs~9.2A/μs
	Min. Rise Time(Pro.)	20μs(Typical)			20μs(Typical)		
	Min. Rise Time(Adv.)	50μs(Typical)			50μs(Typical)		
	Resolution	1mA/μs	5mA/μs	10mA/μs	1mA/μs	5mA/μs	10mA/μs
	Accuracy	5%±10us			5%±10us		
Measurement							
Voltage	Range	0~80V	0~150V	0~600V	0~80V	0~150V	0~600V
	Resolution	0.5mV	1mV	5mV	0.5mV	1mV	5mV
	Accuracy	0.015%+0.015%F.S.			0.015%+0.015%F.S.		
Current	Range	0~80A	0~400A	0~800A	0~92A	0~460A	0~920A
	Resolution	1mA	5mA	10mA	1mA	5mA	10mA
	Accuracy	0.04%+0.04%F.S.			0.04%+0.04%F.S.		
Power	Range	0~1100W	0~5500W	0~11000W	0~1250W	0~6250W	0~12500W
	Resolution	20mW	100mW	200mW	20mW	100mW	200mW
	Accuracy	0.1%+0.1%F.S.			0.1%+0.1%F.S.		
Sampling Frequency	500kHz			500kHz			
Protection							
OVP	88V	165V	660V	88V	165V	660V	
OCP	81.6A	408A	816A	93.84A	469.2A	938.4A	
OPP	1133W	5665W	11330W	1287.5W	6437.5W	12875W	
Over Temperature	70-75°C			70-75°C			
Overvoltage Safety Value	110%V.F.S.			110%V.F.S.			
Reverse Alarm	Yes			Yes			
Alarm Tone	Yes			Yes			
Mechanical							
Dimensions(WxHxD)	423.0x311.0x670.0 mm			423.0x311.0x670.0 mm			
Package Dimensions(WxHxD)	541.0x591.0x891.0 mm			541.0x591.0x891.0 mm			
Unit Weight	67kg			71kg			
Shipping Weight	87kg			91kg			
AC Input							
Voltage	100~240Vac			100~240Vac			
Frequency	50~60Hz			50~60Hz			
Power	500VA			550VA			
Fuse	5A			5A			

EL Series High-density Programmable DC Electronic Load

MODEL		EL600VDC13200W			EL600VDC14700W		
Rated	Voltage	0~600V			0~600V		
	Current	0~960A			0~1080A		
	Power	0~13200W			0~14700W		
	Min. Operating Voltage	0.8V@96A	4V@480A	8V@960A	0.8V@108A	4V@540A	8V@1080A
Static Mode							
Constant Current Mode	Range	0~96A	0~480A	0~960A	0~108A	0~540A	0~1080A
	Resolution	1mA	5mA	10mA	1mA	5mA	10mA
	Accuracy	0.05%+0.05%F.S.			0.05%+0.05%F.S.		
Constant Voltage Mode	Range	0~80V	0~150V	0~600V	0~80V	0~150V	0~600V
	Resolution	0.5mV	1mV	5mV	0.5mV	1mV	5mV
	Accuracy	0.025%+0.025%F.S.			0.025%+0.025%F.S.		
Constant Power Mode	Range	0~1320W	0~6600W	0~13200W	0~1470W	0~7350W	0~14700W
	Resolution	40mW	200mW	400mW	40mW	200mW	400mW
	Accuracy	0.2%+0.2%F.S.			0.2%+0.2%F.S.		
Constant Resistance Mode	Range	25mΩ~250Ω(80V)	100mΩ~1000Ω(150V)	1000mΩ~2000Ω(600V)	25mΩ~250Ω(80V)	100mΩ~1000Ω(150V)	1000mΩ~2000Ω(600V)
	Resolution	25mΩ(80V)	100mΩ(150V)	1000mΩ(600V)	25mΩ(80V)	100mΩ(150V)	1000mΩ(600V)
	Accuracy	Vin/Rset*(0.2%)+0.2% I.F.S.			Vin/Rset*(0.2%)+0.2% I.F.S.		
Dynamic Mode							
CCD/CRD	T1&T2(Pro.)	0.02ms~300s			0.02ms~300s		
	T1&T2(Adv.)	0.05ms~300s			0.05ms~300s		
	Resolution	1μs			1μs		
	Accuracy	1μs+100ppm			1μs+100ppm		
	Slew Rate(Pro.)	1mA/μs~3A/μs	5mA/μs~15A/μs	10mA/μs~30A/μs	1mA/μs~3A/μs	5mA/μs~15A/μs	10mA/μs~30A/μs
	Slew Rate(Adv.)	1mA/μs~0.96A/μs	5mA/μs~4.8A/μs	10mA/μs~9.6A/μs	1mA/μs~1.08A/μs	5mA/μs~5.4A/μs	10mA/μs~10.8A/μs
	Min. Rise Time(Pro.)	20μs(Typical)			20μs(Typical)		
	Min. Rise Time(Adv.)	50μs(Typical)			50μs(Typical)		
	Resolution	1mA/μs	5mA/μs	10mA/μs	1mA/μs	5mA/μs	10mA/μs
	Accuracy	5%±10us			5%±10us		
Measurement							
Voltage	Range	0~80V	0~150V	0~600V	0~80V	0~150V	0~600V
	Resolution	0.5mV	1mV	5mV	0.5mV	1mV	5mV
	Accuracy	0.015%+0.015%F.S.			0.015%+0.015%F.S.		
Current	Range	0~96A	0~480A	0~960A	0~108A	0~540A	0~1080A
	Resolution	1mA	5mA	10mA	1mA	5mA	10mA
	Accuracy	0.04%+0.04%F.S.			0.04%+0.04%F.S.		
Power	Range	0~1320W	0~6600W	0~13200W	0~1470W	0~7350W	0~14700W
	Resolution	40mW	200mW	400mW	40mW	200mW	400mW
	Accuracy	0.1%+0.1%F.S.			0.1%+0.1%F.S.		
Sampling Frequency	500kHz			500kHz			
Protection							
OVP	88V	165V	660V	88V	165V	660V	
OCP	97.92A	489.6A	979.2A	110.16A	550.8A	1101.6A	
OPP	1359.6W	6798W	13596W	1514.1W	7570.5W	15141W	
Over Temperature	70-75°C			70-75°C			
Overvoltage Safety Value	110%V.F.S.			110%V.F.S.			
Reverse Alarm	Yes			Yes			
Alarm Tone	Yes			Yes			
Mechanical							
Dimensions(WxHxD)	423.0x311.0x670.0 mm			423.0x311.0x670.0 mm			
Package Dimensions(WxHxD)	541.0x591.0x891.0 mm			541.0x591.0x891.0 mm			
Unit Weight	72.5kg			76.5kg			
Shipping Weight	92.5kg			96.5kg			
AC Input							
Voltage	100~240Vac			100~240Vac			
Frequency	50~60Hz			50~60Hz			
Power	550VA			600VA			
Fuse	5A			5A			

EL Series High-density Programmable DC Electronic Load

MODEL		EL600VDC15400W			EL600VDC16900W		
Rated	Voltage	0~600V			0~600V		
	Current	0~1120A			0~1240A		
	Power	0~15400W			0~16900W		
	Min. Operating Voltage	0.8V@112A	4V@560A	8V@1120A	0.8V@124A	4V@620A	8V@1240A
Static Mode							
Constant Current Mode	Range	0~112A	0~560A	0~1120A	0~124A	0~620A	0~1240A
	Resolution	1mA	5mA	10mA	1mA	5mA	10mA
	Accuracy	0.05%+0.05%F.S.			0.05%+0.05%F.S.		
Constant Voltage Mode	Range	0~80V	0~150V	0~600V	0~80V	0~150V	0~600V
	Resolution	0.5mV	1mV	5mV	0.5mV	1mV	5mV
	Accuracy	0.025%+0.025%F.S.			0.025%+0.025%F.S.		
Constant Power Mode	Range	0~1540W	0~7700W	0~15400W	0~1690W	0~8450W	0~16900W
	Resolution	40mW	200mW	400mW	40mW	200mW	400mW
	Accuracy	0.2%+0.2%F.S.			0.2%+0.2%F.S.		
Constant Resistance Mode	Range	21mΩ~210Ω(80V)	85mΩ~850Ω(150V)	850mΩ~1700Ω(600V)	21mΩ~210Ω(80V)	85mΩ~850Ω(150V)	850mΩ~1700Ω(600V)
	Resolution	21mΩ(80V)	85mΩ(150V)	850mΩ(600V)	21mΩ(80V)	85mΩ(150V)	850mΩ(600V)
	Accuracy	Vin/Rset*(0.2%)+0.2% I.F.S.			Vin/Rset*(0.2%)+0.2% I.F.S.		
Dynamic Mode							
CCD/CRD	T1&T2(Pro.)	0.02ms~300s			0.02ms~300s		
	T1&T2(Adv.)	0.05ms~300s			0.05ms~300s		
	Resolution	1μs			1μs		
	Accuracy	1μs+100ppm			1μs+100ppm		
	Slew Rate(Pro.)	1mA/μs~3.2A/μs	5mA/μs~16A/μs	10mA/μs~32A/μs	1mA/μs~3.2A/μs	5mA/μs~16A/μs	10mA/μs~32A/μs
	Slew Rate(Adv.)	1mA/μs~1.12A/μs	5mA/μs~5.6A/μs	10mA/μs~11.2A/μs	1mA/μs~1.24A/μs	5mA/μs~6.2A/μs	10mA/μs~12.4A/μs
	Min. Rise Time(Pro.)	20μs(Typical)			20μs(Typical)		
	Min. Rise Time(Adv.)	50μs(Typical)			50μs(Typical)		
	Resolution	1mA/μs	5mA/μs	10mA/μs	1mA/μs	5mA/μs	10mA/μs
	Accuracy	5%±10us			5%±10us		
Measurement							
Voltage	Range	0~80V	0~150V	0~600V	0~80V	0~150V	0~600V
	Resolution	0.5mV	1mV	5mV	0.5mV	1mV	5mV
	Accuracy	0.015%+0.015%F.S.			0.015%+0.015%F.S.		
Current	Range	0~112A	0~560A	0~1120A	0~124A	0~620A	0~1240A
	Resolution	1mA	5mA	10mA	1mA	5mA	10mA
	Accuracy	0.04%+0.04%F.S.			0.04%+0.04%F.S.		
Power	Range	0~1540W	0~7700W	0~15400W	0~1690W	0~8450W	0~16900W
	Resolution	40mW	200mW	400mW	40mW	200mW	400mW
	Accuracy	0.1%+0.1%F.S.			0.1%+0.1%F.S.		
Sampling Frequency	500kHz			500kHz			
Protection							
OVP	88V	165V	660V	88V	165V	660V	
OCP	114.24A	571.2A	1142.4A	126.48A	632.4A	1264.8A	
OPP	1586.2W	7931W	15862W	1740.7W	8703.5W	17407W	
Over Temperature	70-75°C			70-75°C			
Overvoltage Safety Value	110%V.F.S.			110%V.F.S.			
Reverse Alarm	Yes			Yes			
Alarm Tone	Yes			Yes			
Mechanical							
Dimensions(WxHxD)	423.0x444.0x670.0 mm			423.0x444.0x670.0 mm			
Package Dimensions(WxHxD)	544.0x741.0x891.0 mm			544.0x741.0x891.0 mm			
Unit Weight	94.5kg			98.5kg			
Shipping Weight	116.5kg			120.5kg			
AC Input							
Voltage	100~240Vac			100~240Vac			
Frequency	50~60Hz			50~60Hz			
Power	700VA			750VA			
Fuse	8A			8A			

EL Series High-density Programmable DC Electronic Load

MODEL		EL600VDC17600W			EL600VDC19100W		
Rated	Voltage	0~600V			0~600V		
	Current	0~1280A			0~1400A		
	Power	0~17600W			0~19100W		
	Min. Operating Voltage	0.8V@128A	4V@640A	8V@1280A	0.8V@140A	4V@700A	8V@1400
Static Mode							
Constant Current Mode	Range	0~128A	0~640A	0~1280A	0~140A	0~700A	0~1400
	Resolution	1mA	5mA	10mA	1mA	5mA	10mA
	Accuracy	0.05%+0.05%F.S.			0.05%+0.05%F.S.		
Constant Voltage Mode	Range	0~80V	0~150V	0~600V	0~80V	0~150V	0~600V
	Resolution	0.5mV	1mV	5mV	0.5mV	1mV	5mV
	Accuracy	0.025%+0.025%F.S.			0.025%+0.025%F.S.		
Constant Power Mode	Range	0~1760W	0~8800W	0~17600W	0~1910W	0~9550W	0~19100W
	Resolution	100mW	500mW	1000mW	100mW	500mW	1000mW
	Accuracy	0.2%+0.2%F.S.			0.2%+0.2%F.S.		
Constant Resistance Mode	Range	18.7mΩ~187Ω(80V)	75mΩ~750Ω(150V)	750mΩ~1500Ω(600V)	18.7mΩ~187Ω(80V)	75mΩ~750Ω(150V)	750mΩ~1500Ω(600V)
	Resolution	18.7mΩ(80V)	75mΩ(150V)	750mΩ(600V)	18.7mΩ(80V)	75mΩ(150V)	750mΩ(600V)
	Accuracy	Vin/Rset*(0.2%)+0.2% I.F.S.			Vin/Rset*(0.2%)+0.2% I.F.S.		
Dynamic Mode							
CCD/CRD	T1&T2(Pro.)	0.02ms~300s			0.02ms~300s		
	T1&T2(Adv.)	0.05ms~300s			0.05ms~300s		
	Resolution	1μs			1μs		
	Accuracy	1μs+100ppm			1μs+100ppm		
	Slew Rate(Pro.)	1mA/μs~3.4A/μs	5mA/μs~17A/μs	10mA/μs~34A/μs	1mA/μs~3.4A/μs	5mA/μs~17A/μs	10mA/μs~34A/μs
	Slew Rate(Adv.)	1mA/μs~1.28A/μs	5mA/μs~6.4A/μs	10mA/μs~12.8A/μs	1mA/μs~1.4A/μs	5mA/μs~7A/μs	10mA/μs~14A/μs
	Min. Rise Time(Pro.)	20μs(Typical)			20μs(Typical)		
	Min. Rise Time(Adv.)	50μs(Typical)			50μs(Typical)		
	Resolution	1mA/μs	5mA/μs	10mA/μs	1mA/μs	5mA/μs	10mA/μs
	Accuracy	5%±10us			5%±10us		
Measurement							
Voltage	Range	0~80V	0~150V	0~600V	0~80V	0~150V	0~600V
	Resolution	0.5mV	1mV	5mV	0.5mV	1mV	5mV
	Accuracy	0.015%+0.015%F.S.			0.015%+0.015%F.S.		
Current	Range	0~128A	0~640A	0~1280A	0~140A	0~700A	0~1400A
	Resolution	1mA	5mA	10mA	1mA	5mA	10mA
	Accuracy	0.04%+0.04%F.S.			0.04%+0.04%F.S.		
Power	Range	0~1760W	0~8800W	0~17600W	0~1910W	0~9550W	0~19100W
	Resolution	100mW	500mW	1000mW	100mW	500mW	1000mW
	Accuracy	0.1%+0.1%F.S.			0.1%+0.1%F.S.		
Sampling Frequency	500kHz			500kHz			
Protection							
OVP	88V	165V	660V	88V	165V	660V	
OCP	130.56A	652.8A	1305.6A	142.8A	714A	1428A	
OPP	1812.8W	9064W	18128W	1967.3W	9836.5W	19673W	
Over Temperature	70-75°C			70-75°C			
Overvoltage Safety Value	110%V.F.S.			110%V.F.S.			
Reverse Alarm	Yes			Yes			
Alarm Tone	Yes			Yes			
Mechanical							
Dimensions(WxHxD)	423.0x444.0x670.0 mm			423.0x444.0x670.0 mm			
Package Dimensions(WxHxD)	544.0x741.0x891.0 mm			544.0x741.0x891.0 mm			
Unit Weight	100kg			104kg			
Shipping Weight	122kg			126kg			
AC Input							
Voltage	100~240Vac			100~240Vac			
Frequency	50~60Hz			50~60Hz			
Power	750VA			800VA			
Fuse	8A			8A			

EL Series High-density Programmable DC Electronic Load

MODEL		EL600VDC19800W			EL600VDC21300W		
Rated	Voltage	0~600V			0~600V		
	Current	0~1440A			0~1560A		
	Power	0~19800W			0~21300W		
	Min. Operating Voltage	0.8V@144A	4V@720A	8V@1440A	0.8V@156A	4V@780A	8V@1560A
Static Mode							
Constant Current Mode	Range	0~144A	0~720A	0~1440A	0~156A	0~780A	0~1560A
	Resolution	2mA	10mA	20mA	2mA	10mA	20mA
	Accuracy	0.05%+0.05%F.S.			0.05%+0.05%F.S.		
Constant Voltage Mode	Range	0~80V	0~150V	0~600V	0~80V	0~150V	0~600V
	Resolution	0.5mV	1mV	5mV	0.5mV	1mV	5mV
	Accuracy	0.025%+0.025%F.S.			0.025%+0.025%F.S.		
Constant Power Mode	Range	0~1980W	0~9900W	0~19800W	0~2130W	0~10650W	0~21300W
	Resolution	100mW	500mW	1000mW	100mW	500mW	1000mW
	Accuracy	0.2%+0.2%F.S.			0.2%+0.2%F.S.		
Constant Resistance Mode	Range	16.7mΩ~166.7Ω(80V)	66.7mΩ~666.7Ω(150V)	666.7mΩ~1333Ω(600V)	16.7mΩ~166.7Ω(80V)	66.7mΩ~666.7Ω(150V)	666.7mΩ~1333Ω(600V)
	Resolution	16.7mΩ(80V)	66.7mΩ(150V)	666.7mΩ(600V)	16.7mΩ(80V)	66.7mΩ(150V)	666.7mΩ(600V)
	Accuracy	Vin/Rset*(0.2%)+0.2% I.F.S.			Vin/Rset*(0.2%)+0.2% I.F.S.		
Dynamic Mode							
CCD/CRD	T1&T2(Pro.)	0.02ms~300s			0.02ms~300s		
	T1&T2(Adv.)	0.05ms~300s			0.05ms~300s		
	Resolution	1μs			1μs		
	Accuracy	1μs+100ppm			1μs+100ppm		
	Slew Rate(Pro.)	2mA/μs~3.6A/μs	10mA/μs~18A/μs	20mA/μs~36A/μs	2mA/μs~3.6A/μs	10mA/μs~18A/μs	20mA/μs~36A/μs
	Slew Rate(Adv.)	2mA/μs~1.44A/μs	10mA/μs~7.2A/μs	20mA/μs~14.4A/μs	2mA/μs~1.56A/μs	10mA/μs~7.8A/μs	20mA/μs~15.6A/μs
	Min. Rise Time(Pro.)	20μs(Typical)			20μs(Typical)		
	Min. Rise Time(Adv.)	50μs(Typical)			50μs(Typical)		
	Resolution	2mA/μs	10mA/μs	20mA/μs	2mA/μs	10mA/μs	20mA/μs
	Accuracy	5%±10us			5%±10us		
Measurement							
Voltage	Range	0~80V	0~150V	0~600V	0~80V	0~150V	0~600V
	Resolution	0.5mV	1mV	5mV	0.5mV	1mV	5mV
	Accuracy	0.015%+0.015%F.S.			0.015%+0.015%F.S.		
Current	Range	0~144A	0~720A	0~1440A	0~156A	0~780A	0~1560A
	Resolution	2mA	10mA	20mA	2mA	10mA	20mA
	Accuracy	0.04%+0.04%F.S.			0.04%+0.04%F.S.		
Power	Range	0~1980W	0~9900W	0~19800W	0~2130W	0~10650W	0~21300W
	Resolution	100mW	500mW	1000mW	100mW	500mW	1000mW
	Accuracy	0.1%+0.1%F.S.			0.1%+0.1%F.S.		
Sampling Frequency	500kHz			500kHz			
Protection							
OVP	88V	165V	660V	88V	165V	660V	
OCP	146.88A	734.4A	1468.8A	159.12A	795.6A	1591.2A	
OPP	2039.4W	10197W	20394W	2193.9W	10969.5W	21939W	
Over Temperature	70-75°C			70-75°C			
Overvoltage Safety Value	110%V.F.S.			110%V.F.S.			
Reverse Alarm	Yes			Yes			
Alarm Tone	Yes			Yes			
Mechanical							
Dimensions(WxHxD)	423.0x444.0x670.0 mm			423.0x444.0x670.0 mm			
Package Dimensions(WxHxD)	544.0x741.0x891.0 mm			544.0x741.0x891.0 mm			
Unit Weight	105.5kg			109.5kg			
Shipping Weight	127.5kg			131.5kg			
AC Input							
Voltage	100~240Vac			100~240Vac			
Frequency	50~60Hz			50~60Hz			
Power	800VA			850VA			
Fuse	8A			8A			

EL Series High-density Programmable DC Electronic Load

MODEL		EL600VDC22000W			EL600VDC23500W		
Rated	Voltage	0~600V			0~600V		
	Current	0~1600A			0~1720A		
	Power	0~22000W			0~23500W		
	Min. Operating Voltage	0.8V@160A	4V@800A	8V@1600A	0.8V@172A	4V@860A	8V@1720A
Static Mode							
Constant Current Mode	Range	0~160A	0~800A	0~1600A	0~172A	0~860A	0~1720A
	Resolution	2mA	10mA	20mA	2mA	10mA	20mA
	Accuracy	0.05%+0.05%F.S.			0.05%+0.05%F.S.		
Constant Voltage Mode	Range	0~80V	0~150V	0~600V	0~80V	0~150V	0~600V
	Resolution	0.5mV	1mV	5mV	0.5mV	1mV	5mV
	Accuracy	0.025%+0.025%F.S.			0.025%+0.025%F.S.		
Constant Power Mode	Range	0~2200W	0~11000W	0~22000W	0~2350W	0~11750W	0~23500W
	Resolution	100mW	500mW	1000mW	100mW	500mW	1000mW
	Accuracy	0.2%+0.2%F.S.			0.2%+0.2%F.S.		
Constant Resistance Mode	Range	15mΩ~150Ω(80V)	60mΩ~600Ω(150V)	600mΩ~1200Ω(600V)	15mΩ~150Ω(80V)	60mΩ~600Ω(150V)	600mΩ~1200Ω(600V)
	Resolution	15mΩ(80V)	60mΩ(150V)	600mΩ(600V)	15mΩ(80V)	60mΩ(150V)	600mΩ(600V)
	Accuracy	Vin/Rset*(0.2%)+0.2% I.F.S.			Vin/Rset*(0.2%)+0.2% I.F.S.		
Dynamic Mode							
CCD/CRD	T1&T2(Pro.)	0.02ms~300s			0.02ms~300s		
	T1&T2(Adv.)	0.05ms~300s			0.05ms~300s		
	Resolution	1μs			1μs		
	Accuracy	1μs+100ppm			1μs+100ppm		
	Slew Rate(Pro.)	2mA/μs~3.8A/μs	10mA/μs~19A/μs	20mA/μs~38A/μs	2mA/μs~3.8A/μs	10mA/μs~19A/μs	20mA/μs~38A/μs
	Slew Rate(Adv.)	2mA/μs~1.6A/μs	10mA/μs~8A/μs	20mA/μs~16A/μs	2mA/μs~1.72A/μs	10mA/μs~8.6A/μs	20mA/μs~17.2A/μs
	Min. Rise Time(Pro.)	20μs(Typical)			20μs(Typical)		
	Min. Rise Time(Adv.)	50μs(Typical)			50μs(Typical)		
	Resolution	2mA/μs	10mA/μs	20mA/μs	2mA/μs	10mA/μs	20mA/μs
	Accuracy	5%±10us			5%±10us		
Measurement							
Voltage	Range	0~80V	0~150V	0~600V	0~80V	0~150V	0~600V
	Resolution	0.5mV	1mV	5mV	0.5mV	1mV	5mV
	Accuracy	0.015%+0.015%F.S.			0.015%+0.015%F.S.		
Current	Range	0~160A	0~800A	0~1600A	0~172A	0~860A	0~1720A
	Resolution	2mA	10mA	20mA	2mA	10mA	20mA
	Accuracy	0.04%+0.04%F.S.			0.04%+0.04%F.S.		
Power	Range	0~2200W	0~11000W	0~22000W	0~2350W	0~11750W	0~23500W
	Resolution	100mW	500mW	1000mW	100mW	500mW	1000mW
	Accuracy	0.1%+0.1%F.S.			0.1%+0.1%F.S.		
Sampling Frequency	500kHz			500kHz			
Protection							
OVP	88V	165V	660V	88V	165V	660V	
OCP	163.2A	816A	1632A	175.44A	877.2A	1754.4A	
OPP	2266W	11330W	22660W	2420.5W	12102.5W	24205W	
Over Temperature	70-75°C			70-75°C			
Overvoltage Safety Value	110%V.F.S.			110%V.F.S.			
Reverse Alarm	Yes			Yes			
Alarm Tone	Yes			Yes			
Mechanical							
Dimensions(WxHxD)	423.0x577.0x670.0 mm			423.0x577.0x670.0 mm			
Package Dimensions(WxHxD)	541.0x861.0x891.0 mm			541.0x861.0x891.0 mm			
Unit Weight	129kg			133kg			
Shipping Weight	153kg			157kg			
AC Input							
Voltage	100~240Vac			100~240Vac			
Frequency	50~60Hz			50~60Hz			
Power	950VA			1000VA			
Fuse	10A			10A			

EL Series High-density Programmable DC Electronic Load

MODEL		EL600VDC24200W			EL600VDC25700W		
Rated	Voltage	0~600V			0~600V		
	Current	0~1760A			0~1880A		
	Power	0~24200W			0~25700W		
	Min. Operating Voltage	0.8V@176A	4V@880A	8V@1760A	0.8V@188A	4V@940A	8V@1880A
Static Mode							
Constant Current Mode	Range	0~176A	0~880A	0~1760A	0~188A	0~940A	0~1880A
	Resolution	2mA	10mA	20mA	2mA	10mA	20mA
	Accuracy	0.05%+0.05%F.S.			0.05%+0.05%F.S.		
Constant Voltage Mode	Range	0~80V	0~150V	0~600V	0~80V	0~150V	0~600V
	Resolution	0.5mV	1mV	5mV	0.5mV	1mV	5mV
	Accuracy	0.025%+0.025%F.S.			0.025%+0.025%F.S.		
Constant Power Mode	Range	0~2420W	0~12100W	0~24200W	0~2570W	0~12850W	0~25700W
	Resolution	100mW	500mW	1000mW	100mW	500mW	1000mW
	Accuracy	0.2%+0.2%F.S.			0.2%+0.2%F.S.		
Constant Resistance Mode	Range	13.6mΩ~136Ω(80V)	55mΩ~550Ω(150V)	550mΩ~1100Ω(600V)	13.6mΩ~136Ω(80V)	55mΩ~550Ω(150V)	550mΩ~1100Ω(600V)
	Resolution	13.6mΩ(80V)	55mΩ(150V)	550mΩ(600V)	13.6mΩ(80V)	55mΩ(150V)	550mΩ(600V)
	Accuracy	Vin/Rset*(0.2%)+0.2% I.F.S.			Vin/Rset*(0.2%)+0.2% I.F.S.		
Dynamic Mode							
CCD/CRD	T1&T2(Pro.)	0.02ms~300s			0.02ms~300s		
	T1&T2(Adv.)	0.05ms~300s			0.05ms~300s		
	Resolution	1μs			1μs		
	Accuracy	1μs+100ppm			1μs+100ppm		
	Slew Rate(Pro.)	2mA/μs~4A/μs	10mA/μs~20A/μs	20mA/μs~40A/μs	2mA/μs~4A/μs	10mA/μs~20A/μs	20mA/μs~40A/μs
	Slew Rate(Adv.)	2mA/μs~1.76A/μs	10mA/μs~8.8A/μs	20mA/μs~17.6A/μs	2mA/μs~1.88A/μs	10mA/μs~9.4A/μs	20mA/μs~18.8A/μs
	Min. Rise Time(Pro.)	20μs(Typical)			20μs(Typical)		
	Min. Rise Time(Adv.)	50μs(Typical)			50μs(Typical)		
	Resolution	2mA/μs	10mA/μs	20mA/μs	2mA/μs	10mA/μs	20mA/μs
	Accuracy	5%±10us			5%±10us		
Measurement							
Voltage	Range	0~80V	0~150V	0~600V	0~80V	0~150V	0~600V
	Resolution	0.5mV	1mV	5mV	0.5mV	1mV	5mV
	Accuracy	0.015%+0.015%F.S.			0.015%+0.015%F.S.		
Current	Range	0~176A	0~880A	0~1760A	0~188A	0~940A	0~1880A
	Resolution	2mA	10mA	20mA	2mA	10mA	20mA
	Accuracy	0.04%+0.04%F.S.			0.04%+0.04%F.S.		
Power	Range	0~2420W	0~12100W	0~24200W	0~2570W	0~12850W	0~25700W
	Resolution	100mW	500mW	1000mW	100mW	500mW	1000mW
	Accuracy	0.1%+0.1%F.S.			0.1%+0.1%F.S.		
Sampling Frequency	500kHz			500kHz			
Protection							
OVP	88V	165V	660V	88V	165V	660V	
OCP	179.52A	897.6A	1795.2A	191.76A	958.8A	1917.6A	
OPP	2492.6W	12463W	24926W	2647.1W	13235.5W	26471W	
Over Temperature	70-75°C			70-75°C			
Overvoltage Safety Value	110%V.F.S.			110%V.F.S.			
Reverse Alarm	Yes			Yes			
Alarm Tone	Yes			Yes			
Mechanical							
Dimensions(WxHxD)	423.0x577.0x670.0 mm			423.0x577.0x670.0 mm			
Package Dimensions(WxHxD)	541.0x861.0x891.0 mm			541.0x861.0x891.0 mm			
Unit Weight	134.5kg			138.5kg			
Shipping Weight	158.5kg			162.5kg			
AC Input							
Voltage	100~240Vac			100~240Vac			
Frequency	50~60Hz			50~60Hz			
Power	1000VA			1050VA			
Fuse	10A			10A			

EL Series High-density Programmable DC Electronic Load

MODEL		EL600VDC26400W			EL600VDC27900W		
Rated	Voltage	0~600V			0~600V		
	Current	0~1920A			0~2040A		
	Power	0~26400W			0~27900W		
	Min. Operating Voltage	0.8V@192A	4V@960A	8V@1920A	0.8V@204A	4V@1020A	8V@2040A
Static Mode							
Constant Current Mode	Range	0~192A	0~960A	0~1920A	0~204A	0~1020A	0~2040A
	Resolution	2mA	10mA	20mA	2mA	10mA	20mA
	Accuracy	0.05%+0.05%F.S.			0.05%+0.05%F.S.		
Constant Voltage Mode	Range	0~80V	0~150V	0~600V	0~80V	0~150V	0~600V
	Resolution	0.5mV	1mV	5mV	0.5mV	1mV	5mV
	Accuracy	0.025%+0.025%F.S.			0.025%+0.025%F.S.		
Constant Power Mode	Range	0~2640W	0~13200W	0~26400W	0~2790W	0~13950W	0~27900W
	Resolution	100mW	500mW	1000mW	100mW	500mW	1000mW
	Accuracy	0.2%+0.2%F.S.			0.2%+0.2%F.S.		
Constant Resistance Mode	Range	12.5mΩ~125Ω(80V)	50mΩ~500Ω(150V)	500mΩ~1000Ω(600V)	12.5mΩ~125Ω(80V)	50mΩ~500Ω(150V)	500mΩ~1000Ω(600V)
	Resolution	12.5mΩ(80V)	50mΩ(150V)	500mΩ(600V)	12.5mΩ(80V)	50mΩ(150V)	500mΩ(600V)
	Accuracy	Vin/Rset*(0.2%)+0.2% I.F.S.			Vin/Rset*(0.2%)+0.2% I.F.S.		
Dynamic Mode							
CCD/CRD	T1&T2(Pro.)	0.02ms~300s			0.02ms~300s		
	T1&T2(Adv.)	0.05ms~300s			0.05ms~300s		
	Resolution	1μs			1μs		
	Accuracy	1μs+100ppm			1μs+100ppm		
	Slew Rate(Pro.)	2mA/μs~4.2A/μs	10mA/μs~21A/μs	20mA/μs~42A/μs	2mA/μs~4.2A/μs	10mA/μs~21A/μs	20mA/μs~42A/μs
	Slew Rate(Adv.)	2mA/μs~1.92A/μs	10mA/μs~9.6A/μs	20mA/μs~19.2A/μs	2mA/μs~2.04A/μs	10mA/μs~10.2A/μs	20mA/μs~20.4A/μs
	Min. Rise Time(Pro.)	20μs(Typical)			20μs(Typical)		
	Min. Rise Time(Adv.)	50μs(Typical)			50μs(Typical)		
	Resolution	2mA/μs	10mA/μs	20mA/μs	2mA/μs	10mA/μs	20mA/μs
	Accuracy	5%±10us			5%±10us		
Measurement							
Voltage	Range	0~80V	0~150V	0~600V	0~80V	0~150V	0~600V
	Resolution	0.5mV	1mV	5mV	0.5mV	1mV	5mV
	Accuracy	0.015%+0.015%F.S.			0.015%+0.015%F.S.		
Current	Range	0~192A	0~960A	0~1920A	0~204A	0~1020A	0~2040A
	Resolution	2mA	10mA	20mA	2mA	10mA	20mA
	Accuracy	0.04%+0.04%F.S.			0.04%+0.04%F.S.		
Power	Range	0~2640W	0~13200W	0~26400W	0~2790W	0~13950W	0~27900W
	Resolution	100mW	500mW	1000mW	100mW	500mW	1000mW
	Accuracy	0.1%+0.1%F.S.			0.1%+0.1%F.S.		
Sampling Frequency	500kHz			500kHz			
Protection							
OVP	88V	165V	660V	88V	165V	660V	
OCP	195.84A	979.2A	1958.4A	208.08A	1040.4A	2080.8A	
OPP	2719.2W	13596W	27192W	2873.7W	14368.5W	28737W	
Over Temperature	70-75°C			70-75°C			
Overvoltage Safety Value	110%V.F.S.			110%V.F.S.			
Reverse Alarm	Yes			Yes			
Alarm Tone	Yes			Yes			
Mechanical							
Dimensions(WxHxD)	423.0x577.0x670.0 mm			423.0x577.0x670.0 mm			
Package Dimensions(WxHxD)	541.0x861.0x891.0 mm			541.0x861.0x891.0 mm			
Unit Weight	140kg			144kg			
Shipping Weight	164kg			168kg			
AC Input							
Voltage	100~240Vac			100~240Vac			
Frequency	50~60Hz			50~60Hz			
Power	1050VA			1100VA			
Fuse	10A			10A			

EL Series High-density Programmable DC Electronic Load

600V Series System Specifications			
Non Linear Mode			
Range	CL	30uF~5000uF	
	RL	As CR Mode	
	Ls	0.1uH~16uH	
	Rs	30mΩ~20Ω	
Resolution	CL	1uF	
	RL	As CR Mode	
	Ls	0.1uH	
	Rs	1mΩ	
Battery Discharge Mode			
Battery Voltage	As CV Mode		
Current Resolution	As CC Mode		
Record	AH/WH		
Test Time	1s~100000s		
Time Resolution	1s		
Program Mode			
Step No.	300 Max.		
Dwell	0.1ms~4000s		
Spec Check	Voltage/Current/Power		
External Waveform Control/Monitor			
Control/Monitor	Voltage/Current		
Input/Output Range	0~10V		
Voltage Range	0~L_range F.S.	0~M_range F.S.	0~H_range F.S.
Current Range	0~L_range F.S.	0~M_range F.S.	0~H_range F.S.
Accuracy	0.4%F.S.		
Resolution	4mV		
Bandwidth	20kHz		
Input Impedance	10kΩ		
Short Circuit			
Current(CC)	Full range current value		
Voltage(CV)	Voltage value at the Max power in working mode		
Resistance(CR)	Min resistance value of CR Mode		
Master/Slave			
Parallel Interface	RJ45		
Parallel Quantity (Pro.)	20 units		
Parallel Quantity (Adv.)	20 units		
General			
Graphic Display	4.3" Color touch LCD		
Operation Key Feature	Soft key, Numeric key, Rotary Knob, USB port for transfer and upgrading firmware		
Rack Mount Handles	Yes		
FAN	Temperature Control		
Interface	RS232/RS485/USB(Standard), GPIB/LAN(Optional)		
Communication Response Time	30ms		
Storage Capacity	User defined settings (300 sets), OCP settings (10 sets), OPP settings (10 sets), Default settings (1 set), Factory setting (1 set)		
Environmental			
Operating Temperature	0~40°C		
Storage Temperature	-20~80°C		
Temperature Coefficient	100ppm/°C(Typical)		
Relative Humidity	10~90%RH		
Altitude	<2000m		
Regulatory Compliance			
Overvoltage Category	II		
Protection Degree	I		
Pollution Degree	II		
Input Impedance	1MΩ(Typical)		
Isolation Voltage	/		
Certificates	CE		

All specifications are subject to change without notice.

EL Series High-density Programmable DC Electronic Load

MODEL		EL1200VDC1200W			EL1200VDC2400W		
Rated	Voltage	0~1200V			0~1200V		
	Current	0~45A			0~90A		
	Power	0~1200W			0~2400W		
	Min. Operating Voltage	2V@4.5A	10V@22.5A	20V@45A	2V@9A	10V@45A	20V@90A
Static Mode							
Constant Current Mode	Range	0~4.5A	0~22.5A	0~45A	0~9A	0~45A	0~90A
	Resolution	0.1mA	0.5mA	1mA	0.1mA	0.5mA	1mA
	Accuracy	0.05%+0.05%F.S.			0.05%+0.05%F.S.		
Constant Voltage Mode	Range	0~150V	0~600V	0~1200V	0~150V	0~600V	0~1200V
	Resolution	1mV	5mV	10mV	1mV	5mV	10mV
	Accuracy	0.025%+0.025%F.S.			0.025%+0.025%F.S.		
Constant Power Mode	Range	0~120W	0~600W	0~1200W	0~240W	0~1200W	0~2400W
	Resolution	2mW	10mW	20mW	5mW	25mW	50mW
	Accuracy	0.2%+0.2%F.S.			0.2%+0.2%F.S.		
Constant Resistance Mode	Range	275mΩ~2750Ω(150V)	1100mΩ~11000Ω(600V)	11000mΩ~22000Ω(1200V)	137.5mΩ~1375Ω(150V)	550mΩ~5500Ω(600V)	5500mΩ~11000Ω(1200V)
	Resolution	275mΩ(150V)	1100mΩ(600V)	11000mΩ(1200V)	150mΩ(150V)	600mΩ(600V)	6000mΩ(1200V)
	Accuracy	Vin/Rset*(0.2%)+0.2% I.F.S.			Vin/Rset*(0.2%)+0.2% I.F.S.		
Dynamic Mode							
CCD/CRD	T1&T2(Pro.)	0.02ms~300s			0.02ms~300s		
	T1&T2(Adv.)	0.05ms~300s			0.05ms~300s		
	Resolution	1μs			1μs		
	Accuracy	1μs+100ppm			1μs+100ppm		
	Slew Rate(Pro.)	0.1mA/μs~0.225A/μs	0.5mA/μs~1.125A/μs	1mA/μs~2.25A/μs	0.1mA/μs~0.45A/μs	0.5mA/μs~2.25A/μs	1mA/μs~4.5A/μs
	Slew Rate(Adv.)	0.1mA/μs~0.045A/μs	0.5mA/μs~0.225A/μs	1mA/μs~0.45A/μs	0.1mA/μs~0.09A/μs	0.5mA/μs~0.45A/μs	1mA/μs~0.9A/μs
	Min. Rise Time(Pro.)	20μs(Typical)			20μs(Typical)		
	Min. Rise Time(Adv.)	50μs(Typical)			50μs(Typical)		
	Resolution	0.1mA/μs	0.5mA/μs	1mA/μs	0.1mA/μs	0.5mA/μs	1mA/μs
	Accuracy	5%±10us			5%±10us		
Measurement							
Voltage	Range	0~150V	0~600V	0~1200V	0~150V	0~600V	0~1200V
	Resolution	1mV	5mV	10mV	1mV	5mV	10mV
	Accuracy	0.015%+0.015%F.S.			0.015%+0.015%F.S.		
Current	Range	0~4.5A	0~22.5A	0~45A	0~9A	0~45A	0~90A
	Resolution	0.1mA	0.5mA	1mA	0.1mA	0.5mA	1mA
	Accuracy	0.04%+0.06%F.S.			0.04%+0.06%F.S.		
Power	Range	0~120W	0~600W	0~1200W	0~240W	0~1200W	0~2400W
	Resolution	2mW	10mW	20mW	5mW	25mW	50mW
	Accuracy	0.1%+0.1%F.S.			0.1%+0.1%F.S.		
Sampling Frequency	500kHz			500kHz			
Protection							
OVP	165V	660V	1320V	165V	660V	1320V	
OCP	4.59A	22.95A	45.9A	9.18A	45.9A	91.8A	
OPP	123.6W	618W	1236W	247.2W	1236W	2472W	
Over Temperature	70-75°C			70-75°C			
Overvoltage Safety Value	110%V.F.S.			110%V.F.S.			
Reverse Alarm	Yes			Yes			
Alarm Tone	Yes			Yes			
Mechanical							
Dimensions(WxHxD)	423.0x88.0x610.0 mm			423.0x88.0x610.0 mm			
Package Dimensions(WxHxD)	665.0x333.0x918.0 mm			665.0x333.0x918.0 mm			
Unit Weight	20kg			24kg			
Shipping Weight	29kg			33kg			
AC Input							
Voltage	100~240Vac			100~240Vac			
Frequency	50~60Hz			50~60Hz			
Power	125VA			150VA			
Fuse	2.5A			2.5A			

EL Series High-density Programmable DC Electronic Load

MODEL		EL1200VDC3400W			EL1200VDC4400W		
Rated	Voltage	0~1200V			0~1200V		
	Current	0~125A			0~160A		
	Power	0~3400W			0~4400W		
	Min. Operating Voltage	2V@12.5A	10V@62.5A	20V@125A	2V@16A	10V@80A	20V@160A
Static Mode							
Constant Current Mode	Range	0~12.5A	0~62.5A	0~125A	0~16A	0~80A	0~160A
	Resolution	0.2mA	1mA	2mA	0.2mA	1mA	2mA
	Accuracy	0.05%+0.05%F.S.			0.05%+0.05%F.S.		
Constant Voltage Mode	Range	0~150V	0~600V	0~1200V	0~150V	0~600V	0~1200V
	Resolution	1mV	5mV	10mV	1mV	5mV	10mV
	Accuracy	0.025%+0.025%F.S.			0.025%+0.025%F.S.		
Constant Power Mode	Range	0~340W	0~1700W	0~3400W	0~440W	0~2200W	0~4400W
	Resolution	10mW	50mW	100mW	10mW	50mW	100mW
	Accuracy	0.2%+0.2%F.S.			0.2%+0.2%F.S.		
Constant Resistance Mode	Range	100mΩ~1000Ω(150V)	400mΩ~4000Ω(600V)	4000mΩ~8000Ω(1200V)	75mΩ~750Ω(150V)	300mΩ~3000Ω(600V)	3000mΩ~6000Ω(1200V)
	Resolution	100mΩ(150V)	400mΩ(600V)	4000mΩ(1200V)	75mΩ(150V)	300mΩ(600V)	3000mΩ(1200V)
	Accuracy	Vin/Rset*(0.2%)+0.2% I.F.S.			Vin/Rset*(0.2%)+0.2% I.F.S.		
Dynamic Mode							
CCD/CRD	T1&T2(Pro.)	0.02ms~300s			0.02ms~300s		
	T1&T2(Adv.)	0.05ms~300s			0.05ms~300s		
	Resolution	1μs			1μs		
	Accuracy	1μs+100ppm			1μs+100ppm		
	Slew Rate(Pro.)	0.2mA/μs~0.625A/μs	1mA/μs~3.125A/μs	2mA/μs~6.25A/μs	0.2mA/μs~0.8A/μs	1mA/μs~4A/μs	2mA/μs~8A/μs
	Slew Rate(Adv.)	0.2mA/μs~0.125A/μs	1mA/μs~0.625A/μs	2mA/μs~1.25A/μs	0.2mA/μs~0.16A/μs	1mA/μs~0.8A/μs	2mA/μs~1.6A/μs
	Min. Rise Time(Pro.)	20μs(Typical)			20μs(Typical)		
	Min. Rise Time(Adv.)	50μs(Typical)			50μs(Typical)		
	Resolution	0.2mA/μs	1mA/μs	2mA/μs	0.2mA/μs	1mA/μs	2mA/μs
	Accuracy	5%±10us			5%±10us		
Measurement							
Voltage	Range	0~150V	0~600V	0~1200V	0~150V	0~600V	0~1200V
	Resolution	1mV	5mV	10mV	1mV	5mV	10mV
	Accuracy	0.015%+0.015%F.S.			0.015%+0.015%F.S.		
Current	Range	0~12.5A	0~62.5A	0~125A	0~16A	0~80A	0~160A
	Resolution	0.2mA	1mA	2mA	0.2mA	1mA	2mA
	Accuracy	0.04%+0.06%F.S.			0.04%+0.06%F.S.		
Power	Range	0~340W	0~1700W	0~3400W	0~440W	0~2200W	0~4400W
	Resolution	10mW	50mW	100mW	10mW	50mW	100mW
	Accuracy	0.1%+0.1%F.S.			0.1%+0.1%F.S.		
Sampling Frequency	500kHz			500kHz			
Protection							
OVP	165V	660V	1320V	165V	660V	1320V	
OCP	12.75A	63.75A	127.5A	16.32A	81.6A	163.2A	
OPP	350.2W	1751W	3502W	453.2W	2266W	4532W	
Over Temperature	70-75°C			70-75°C			
Overvoltage Safety Value	110%V.F.S.			110%V.F.S.			
Reverse Alarm	Yes			Yes			
Alarm Tone	Yes			Yes			
Mechanical							
Dimensions(WxHxD)	423.0x133.0x610.0 mm			423.0x133.0x610.0 mm			
Package Dimensions(WxHxD)	665.0x348.0x918.0 mm			665.0x348.0x918.0 mm			
Unit Weight	27kg			28.5kg			
Shipping Weight	36kg			37.5kg			
AC Input							
Voltage	100~240Vac			100~240Vac			
Frequency	50~60Hz			50~60Hz			
Power	225VA			250VA			
Fuse	2.5A			2.5A			

EL Series High-density Programmable DC Electronic Load

MODEL		EL1200VDC5600W		
Rated	Voltage	0~1200V		
	Current	0~205A		
	Power	0~5600W		
	Min. Operating Voltage	2V@20.5A	10V@102.5A	20V@205A
Static Mode				
Constant Current Mode	Range	0~20.5A	0~102.5A	0~205A
	Resolution	0.2mA	1mA	2mA
	Accuracy	0.05%+0.05%F.S.		
Constant Voltage Mode	Range	0~150V	0~600V	0~1200V
	Resolution	1mV	5mV	10mV
	Accuracy	0.025%+0.025%F.S.		
Constant Power Mode	Range	0~560W	0~2800W	0~5600W
	Resolution	10mW	50mW	100mW
	Accuracy	0.2%+0.2%F.S.		
Constant Resistance Mode	Range	60mΩ~600Ω(150V)	235mΩ~2300Ω(600V)	2350mΩ~4700Ω(1200V)
	Resolution	60mΩ(150V)	235mΩ(600V)	2350mΩ(1200V)
	Accuracy	Vin/Rset*(0.2%)+0.2% I.F.S.		
Dynamic Mode				
CCD/CRD	T1&T2(Pro.)	0.02ms~300s		
	T1&T2(Adv.)	0.05ms~300s		
	Resolution	1μs		
	Accuracy	1μs+100ppm		
	Slew Rate(Pro.)	0.2mA/μs~1.025A/μs	1mA/μs~5.125A/μs	2mA/μs~10.25A/μs
	Slew Rate(Adv.)	0.2mA/μs~0.205A/μs	1mA/μs~1.025A/μs	2mA/μs~2.05A/μs
	Min. Rise Time(Pro.)	20μs(Typical)		
	Min. Rise Time(Adv.)	50μs(Typical)		
	Resolution	0.2mA/μs	1mA/μs	2mA/μs
	Accuracy	5%±10us		
Measurement				
Voltage	Range	0~150V	0~600V	0~1200V
	Resolution	1mV	5mV	10mV
	Accuracy	0.015%+0.015%F.S.		
Current	Range	0~20.5A	0~102.5A	0~205A
	Resolution	0.2mA	1mA	2mA
	Accuracy	0.04%+0.06%F.S.		
Power	Range	0~560W	0~2800W	0~5600W
	Resolution	10mW	50mW	100mW
	Accuracy	0.1%+0.1%F.S.		
Sampling Frequency	500kHz			
Protection				
OVP	165V	660V	1320V	
OCP	20.91A	104.55A	209.1A	
OPP	576.8W	2884W	5768W	
Over Temperature	70-75°C			
Overvoltage Safety Value	110%V.F.S.			
Reverse Alarm	Yes			
Alarm Tone	Yes			
Mechanical				
Dimensions(WxHxD)	423.0x133.0x610.0 mm			
Package Dimensions(WxHxD)	665.0x348.0x918.0 mm			
Unit Weight	32.5kg			
Shipping Weight	41.5kg			
AC Input				
Voltage	100~240Vac			
Frequency	50~60Hz			
Power	250VA			
Fuse	2.5A			

EL Series High-density Programmable DC Electronic Load

MODEL		EL1200VDC6600W			EL1200VDC8100W		
Rated	Voltage	0~1200V			0~1200V		
	Current	0~240A			0~300A		
	Power	0~6600W			0~8100W		
	Min. Operating Voltage	2V@24A	10V@120A	20V@240A	2V@30A	10V@150A	20V@300A
Static Mode							
Constant Current Mode	Range	0~24A	0~120A	0~240A	0~30A	0~150A	0~300A
	Resolution	0.2mA	1mA	2mA	0.2mA	1mA	2mA
	Accuracy	0.05%+0.05%F.S.			0.05%+0.05%F.S.		
Constant Voltage Mode	Range	0~150V	0~600V	0~1200V	0~150V	0~600V	0~1200V
	Resolution	1mV	5mV	10mV	1mV	5mV	10mV
	Accuracy	0.025%+0.025%F.S.			0.025%+0.025%F.S.		
Constant Power Mode	Range	0~660W	0~3300W	0~6600W	0~810W	0~4050W	0~8100W
	Resolution	10mW	50mW	100mW	10mW	50mW	100mW
	Accuracy	0.2%+0.2%F.S.			0.2%+0.2%F.S.		
Constant Resistance Mode	Range	50mΩ~500Ω(150V)	200mΩ~2000Ω(600V)	2000mΩ~4000Ω(1200V)	50mΩ~500Ω(150V)	200mΩ~2000Ω(600V)	2000mΩ~4000Ω(1200V)
	Resolution	50mΩ(150V)	200mΩ(600V)	2000mΩ(1200V)	50mΩ(150V)	200mΩ(600V)	2000mΩ(1200V)
	Accuracy	Vin/Rset*(0.2%)+0.2% I.F.S.			Vin/Rset*(0.2%)+0.2% I.F.S.		
Dynamic Mode							
CCD/CRD	T1&T2(Pro.)	0.02ms~300s			0.02ms~300s		
	T1&T2(Adv.)	0.05ms~300s			0.05ms~300s		
	Resolution	1μs			1μs		
	Accuracy	1μs+100ppm			1μs+100ppm		
	Slew Rate(Pro.)	0.2mA/μs~1.2A/μs	1mA/μs~6A/μs	2mA/μs~12A/μs	0.2mA/μs~1.2A/μs	1mA/μs~6A/μs	2mA/μs~12A/μs
	Slew Rate(Adv.)	0.2mA/μs~0.24A/μs	1mA/μs~1.2A/μs	2mA/μs~2.4A/μs	0.2mA/μs~0.3A/μs	1mA/μs~1.5A/μs	2mA/μs~3A/μs
	Min. Rise Time(Pro.)	20μs(Typical)			20μs(Typical)		
	Min. Rise Time(Adv.)	50μs(Typical)			50μs(Typical)		
	Resolution	0.2mA/μs	1mA/μs	2mA/μs	0.2mA/μs	1mA/μs	2mA/μs
	Accuracy	5%±10us			5%±10us		
Measurement							
Voltage	Range	0~150V	0~600V	0~1200V	0~150V	0~600V	0~1200V
	Resolution	1mV	5mV	10mV	1mV	5mV	10mV
	Accuracy	0.015%+0.015%F.S.			0.015%+0.015%F.S.		
Current	Range	0~24A	0~120A	0~240A	0~30A	0~150A	0~300A
	Resolution	0.2mA	1mA	2mA	0.2mA	1mA	2mA
	Accuracy	0.04%+0.06%F.S.			0.04%+0.06%F.S.		
Power	Range	0~660W	0~3300W	0~6600W	0~810W	0~4050W	0~8100W
	Resolution	10mW	50mW	100mW	10mW	50mW	100mW
	Accuracy	0.1%+0.1%F.S.			0.1%+0.1%F.S.		
Sampling Frequency	500kHz			500kHz			
Protection							
OVP	165V	660V	1320V	165V	660V	1320V	
OCP	24.48A	122.4A	244.8A	30.6A	153A	306A	
OPP	679.8W	3399W	6798W	834.3W	4171.5W	8343W	
Over Temperature	70-75°C			70-75°C			
Overvoltage Safety Value	110%V.F.S.			110%V.F.S.			
Reverse Alarm	Yes			Yes			
Alarm Tone	Yes			Yes			
Mechanical							
Dimensions(WxHxD)	423.0x177.0x610.0 mm			423.0x177.0x610.0 mm			
Package Dimensions(WxHxD)	665.0x392.0x918.0 mm			665.0x392.0x918.0 mm			
Unit Weight	38kg			42kg			
Shipping Weight	47kg			51kg			
AC Input							
Voltage	100~240Vac			100~240Vac			
Frequency	50~60Hz			50~60Hz			
Power	300VA			350VA			
Fuse	3.15A			3.15A			

EL Series High-density Programmable DC Electronic Load

MODEL		EL1200VDC8800W			EL1200VDC10300W		
Rated	Voltage	0~1200V			0~1200V		
	Current	0~320A			0~380A		
	Power	0~8800W			0~10300W		
	Min. Operating Voltage	2V@32A	10V@160A	20V@320A	2V@38A	10V@190A	20V@380A
Static Mode							
Constant Current Mode	Range	0~32A	0~160A	0~320A	0~38A	0~190A	0~380A
	Resolution	0.4mA	2mA	4mA	0.4mA	2mA	4mA
	Accuracy	0.05%+0.05%F.S.			0.05%+0.05%F.S.		
Constant Voltage Mode	Range	0~150V	0~600V	0~1200V	0~150V	0~600V	0~1200V
	Resolution	1mV	5mV	10mV	1mV	5mV	10mV
	Accuracy	0.025%+0.025%F.S.			0.025%+0.025%F.S.		
Constant Power Mode	Range	0~880W	0~4400W	0~8800W	0~1030W	0~5150W	0~10300W
	Resolution	20mW	100mW	200mW	20mW	100mW	200mW
	Accuracy	0.2%+0.2%F.S.			0.2%+0.2%F.S.		
Constant Resistance Mode	Range	37.5mΩ~375Ω(150V)	150mΩ~1500Ω(600V)	1500mΩ~3000Ω(1200V)	37.5mΩ~375Ω(150V)	150mΩ~1500Ω(600V)	1500mΩ~3000Ω(1200V)
	Resolution	37.5mΩ(150V)	150mΩ(600V)	1500mΩ(1200V)	37.5mΩ(150V)	150mΩ(600V)	1500mΩ(1200V)
	Accuracy	Vin/Rset*(0.2%)+0.2% I.F.S.			Vin/Rset*(0.2%)+0.2% I.F.S.		
Dynamic Mode							
CCD/CRD	T1&T2(Pro.)	0.02ms~300s			0.02ms~300s		
	T1&T2(Adv.)	0.05ms~300s			0.05ms~300s		
	Resolution	1μs			1μs		
	Accuracy	1μs+100ppm			1μs+100ppm		
	Slew Rate(Pro.)	0.4mA/μs~1.28A/μs	2mA/μs~6.4A/μs	4mA/μs~12.8A/μs	0.4mA/μs~1.28A/μs	2mA/μs~6.4A/μs	4mA/μs~12.8A/μs
	Slew Rate(Adv.)	0.4mA/μs~0.32A/μs	2mA/μs~1.6A/μs	4mA/μs~3.2A/μs	0.4mA/μs~0.38A/μs	2mA/μs~1.9A/μs	4mA/μs~3.8A/μs
	Min. Rise Time(Pro.)	20μs(Typical)			20μs(Typical)		
	Min. Rise Time(Adv.)	50μs(Typical)			50μs(Typical)		
	Resolution	0.4mA/μs	2mA/μs	4mA/μs	0.4mA/μs	2mA/μs	4mA/μs
	Accuracy	5%±10us			5%±10us		
Measurement							
Voltage	Range	0~150V	0~600V	0~1200V	0~150V	0~600V	0~1200V
	Resolution	1mV	5mV	10mV	1mV	5mV	10mV
	Accuracy	0.015%+0.015%F.S.			0.015%+0.015%F.S.		
Current	Range	0~32A	0~160A	0~320A	0~38A	0~190A	0~380A
	Resolution	0.4mA	2mA	4mA	0.4mA	2mA	4mA
	Accuracy	0.04%+0.06%F.S.			0.04%+0.06%F.S.		
Power	Range	0~880W	0~4400W	0~8800W	0~1030W	0~5150W	0~10300W
	Resolution	20mW	100mW	200mW	20mW	100mW	200mW
	Accuracy	0.1%+0.1%F.S.			0.1%+0.1%F.S.		
Sampling Frequency	500kHz			500kHz			
Protection							
OVP	165V	660V	1320V	165V	660V	1320V	
OCP	32.64A	163.2A	326.4A	38.76A	193.8A	387.6A	
OPP	906.4W	4532W	9064W	1060.9W	5304.5W	10609W	
Over Temperature	70-75°C			70-75°C			
Overvoltage Safety Value	110%V.F.S.			110%V.F.S.			
Reverse Alarm	Yes			Yes			
Alarm Tone	Yes			Yes			
Mechanical							
Dimensions(WxHxD)	423.0x311.0x670.0 mm			423.0x311.0x670.0 mm			
Package Dimensions(WxHxD)	541.0x591.0x891.0 mm			541.0x591.0x891.0 mm			
Unit Weight	61.5kg			65.5kg			
Shipping Weight	81.5kg			85.5kg			
AC Input							
Voltage	100~240Vac			100~240Vac			
Frequency	50~60Hz			50~60Hz			
Power	450VA			500VA			
Fuse	5A			5A			

EL Series High-density Programmable DC Electronic Load

MODEL		EL1200VDC11000W			EL1200VDC12500W		
Rated	Voltage	0~1200V			0~1200V		
	Current	0~400A			0~460A		
	Power	0~11000W			0~12500W		
	Min. Operating Voltage	2V@40A	10V@200A	20V@400A	2V@46A	10V@230A	20V@~460A
Static Mode							
Constant Current Mode	Range	0~40A	0~200A	0~400A	0~46A	0~230A	0~460A
	Resolution	0.4mA	2mA	4mA	0.4mA	2mA	4mA
	Accuracy	0.05%+0.05%F.S.			0.05%+0.05%F.S.		
Constant Voltage Mode	Range	0~150V	0~600V	0~1200V	0~150V	0~600V	0~1200V
	Resolution	1mV	5mV	10mV	1mV	5mV	10mV
	Accuracy	0.025%+0.025%F.S.			0.025%+0.025%F.S.		
Constant Power Mode	Range	0~1100W	0~5500W	0~11000W	0~1250W	0~6250W	0~12500W
	Resolution	20mW	100mW	200mW	20mW	100mW	200mW
	Accuracy	0.2%+0.2%F.S.			0.2%+0.2%F.S.		
Constant Resistance Mode	Range	30mΩ~300Ω(150V)	120mΩ~1200Ω(600V)	1200mΩ~2400Ω(1200V)	30mΩ~300Ω(150V)	120mΩ~1200Ω(600V)	1200mΩ~2400Ω(1200V)
	Resolution	30mΩ(150V)	120mΩ(600V)	1200mΩ(1200V)	30mΩ(150V)	120mΩ(600V)	1200mΩ(1200V)
	Accuracy	Vin/Rset*(0.2%)+0.2% I.F.S.			Vin/Rset*(0.2%)+0.2% I.F.S.		
Dynamic Mode							
CCD/CRD	T1&T2(Pro.)	0.02ms~300s			0.02ms~300s		
	T1&T2(Adv.)	0.05ms~300s			0.05ms~300s		
	Resolution	1μs			1μs		
	Accuracy	1μs+100ppm			1μs+100ppm		
	Slew Rate(Pro.)	0.4mA/μs~1.44A/μs	2mA/μs~7.2A/μs	4mA/μs~14.4A/μs	0.4mA/μs~1.44A/μs	2mA/μs~7.2A/μs	4mA/μs~14.4A/μs
	Slew Rate(Adv.)	0.4mA/μs~0.4A/μs	2mA/μs~2A/μs	4mA/μs~4A/μs	0.4mA/μs~0.46A/μs	2mA/μs~2.3A/μs	4mA/μs~4.6A/μs
	Min. Rise Time(Pro.)	20μs(Typical)			20μs(Typical)		
	Min. Rise Time(Adv.)	50μs(Typical)			50μs(Typical)		
	Resolution	0.4mA/μs	2mA/μs	4mA/μs	0.4mA/μs	2mA/μs	4mA/μs
	Accuracy	5%±10us			5%±10us		
Measurement							
Voltage	Range	0~150V	0~600V	0~1200V	0~150V	0~600V	0~1200V
	Resolution	1mV	5mV	10mV	1mV	5mV	10mV
	Accuracy	0.015%+0.015%F.S.			0.015%+0.015%F.S.		
Current	Range	0~40A	0~200A	0~400A	0~46A	0~230A	0~460A
	Resolution	0.4mA	2mA	4mA	0.4mA	2mA	4mA
	Accuracy	0.04%+0.06%F.S.			0.04%+0.06%F.S.		
Power	Range	0~1100W	0~5500W	0~11000W	0~1250W	0~6250W	0~12500W
	Resolution	20mW	100mW	200mW	20mW	100mW	200mW
	Accuracy	0.1%+0.1%F.S.			0.1%+0.1%F.S.		
Sampling Frequency	500kHz			500kHz			
Protection							
OVP	165V	660V	1320V	165V	660V	1320V	
OCP	40.8A	204A	408A	46.92A	234.6A	469.2A	
OPP	1133W	5665W	11330W	1287.5W	6437.5W	12875W	
Over Temperature	70-75°C			70-75°C			
Overvoltage Safety Value	110%V.F.S.			110%V.F.S.			
Reverse Alarm	Yes			Yes			
Alarm Tone	Yes			Yes			
Mechanical							
Dimensions(WxHxD)	423.0x311.0x670.0 mm			423.0x311.0x670.0 mm			
Package Dimensions(WxHxD)	541.0x591.0x891.0 mm			541.0x591.0x891.0 mm			
Unit Weight	67kg			71kg			
Shipping Weight	87kg			91kg			
AC Input							
Voltage	100~240Vac			100~240Vac			
Frequency	50~60Hz			50~60Hz			
Power	500VA			550VA			
Fuse	5A			5A			

EL Series High-density Programmable DC Electronic Load

MODEL		EL1200VDC13200W			EL1200VDC14700W		
Rated	Voltage	0~1200V			0~1200V		
	Current	0~480A			0~540A		
	Power	0~13200W			0~14700W		
	Min. Operating Voltage	2V@48A	10V@240A	20V@480A	2V@54A	10V@270A	20V@540A
Static Mode							
Constant Current Mode	Range	0~48A	0~240A	0~480A	0~54A	0~270A	0~540A
	Resolution	0.4mA	2mA	4mA	0.4mA	2mA	4mA
	Accuracy	0.05%+0.05%F.S.			0.05%+0.05%F.S.		
Constant Voltage Mode	Range	0~150V	0~600V	0~1200V	0~150V	0~600V	0~1200V
	Resolution	1mV	5mV	10mV	1mV	5mV	10mV
	Accuracy	0.025%+0.025%F.S.			0.025%+0.025%F.S.		
Constant Power Mode	Range	0~1320W	0~6600W	0~13200W	0~1470W	0~7350W	0~14700W
	Resolution	40mW	200mW	400mW	40mW	200mW	400mW
	Accuracy	0.2%+0.2%F.S.			0.2%+0.2%F.S.		
Constant Resistance Mode	Range	25mΩ~250Ω(150V)	100mΩ~1000Ω(600V)	1000mΩ~2000Ω(1200V)	25mΩ~250Ω(150V)	100mΩ~1000Ω(600V)	1000mΩ~2000Ω(1200V)
	Resolution	25mΩ(150V)	100mΩ(600V)	1000mΩ(1200V)	25mΩ(150V)	100mΩ(600V)	1000mΩ(1200V)
	Accuracy	Vin/Rset*(0.2%)+0.2% I.F.S.			Vin/Rset*(0.2%)+0.2% I.F.S.		
Dynamic Mode							
CCD/CRD	T1&T2(Pro.)	0.02ms~300s			0.02ms~300s		
	T1&T2(Adv.)	0.05ms~300s			0.05ms~300s		
	Resolution	1μs			1μs		
	Accuracy	1μs+100ppm			1μs+100ppm		
	Slew Rate(Pro.)	0.4mA/μs~1.6A/μs	2mA/μs~8A/μs	4mA/μs~16A/μs	0.4mA/μs~1.6A/μs	2mA/μs~8A/μs	4mA/μs~16A/μs
	Slew Rate(Adv.)	0.4mA/μs~0.48A/μs	2mA/μs~2.4A/μs	4mA/μs~4.8A/μs	0.4mA/μs~0.54A/μs	2mA/μs~2.7A/μs	4mA/μs~5.4A/μs
	Min. Rise Time(Pro.)	20μs(Typical)			20μs(Typical)		
	Min. Rise Time(Adv.)	50μs(Typical)			50μs(Typical)		
	Resolution	0.4mA/μs	2mA/μs	4mA/μs	0.4mA/μs	2mA/μs	4mA/μs
	Accuracy	5%±10us			5%±10us		
Measurement							
Voltage	Range	0~150V	0~600V	0~1200V	0~150V	0~600V	0~1200V
	Resolution	1mV	5mV	10mV	1mV	5mV	10mV
	Accuracy	0.015%+0.015%F.S.			0.015%+0.015%F.S.		
Current	Range	0~48A	0~240A	0~480A	0~54A	0~270A	0~540A
	Resolution	0.4mA	2mA	4mA	0.4mA	2mA	4mA
	Accuracy	0.04%+0.06%F.S.			0.04%+0.06%F.S.		
Power	Range	0~1320W	0~6600W	0~13200W	0~1470W	0~7350W	0~14700W
	Resolution	40mW	200mW	400mW	40mW	200mW	400mW
	Accuracy	0.1%+0.1%F.S.			0.1%+0.1%F.S.		
Sampling Frequency	500kHz			500kHz			
Protection							
OVP	165V	660	1320V	165V	660	1320V	
OCP	48.96A	244.8A	489.6A	55.08A	275.4A	550.8A	
OPP	1359.6W	6798W	13596W	1514.1W	7570.5W	15141W	
Over Temperature	70-75°C			70-75°C			
Overvoltage Safety Value	110%V.F.S.			110%V.F.S.			
Reverse Alarm	Yes			Yes			
Alarm Tone	Yes			Yes			
Mechanical							
Dimensions(WxHxD)	423.0x311.0x670.0 mm			423.0x311.0x670.0 mm			
Package Dimensions(WxHxD)	541.0x591.0x891.0 mm			541.0x591.0x891.0 mm			
Unit Weight	72.5kg			76.5kg			
Shipping Weight	92.5kg			96.5kg			
AC Input							
Voltage	100~240Vac			100~240Vac			
Frequency	50~60Hz			50~60Hz			
Power	550VA			600VA			
Fuse	5A			5A			

EL Series High-density Programmable DC Electronic Load

MODEL		EL1200VDC15400W			EL1200VDC16900W		
Rated	Voltage	0~1200V			0~1200V		
	Current	0~560A			0~620A		
	Power	0~15400W			0~16900W		
	Min. Operating Voltage	2V@56A	10V@280A	20V@560A	2V@62A	10V@310A	20V@620A
Static Mode							
Constant Current Mode	Range	0~56A	0~280A	0~560A	0~62A	0~310A	0~620A
	Resolution	0.5mA	2mA	5mA	0.5mA	2mA	5mA
	Accuracy	0.05%+0.05%F.S.			0.05%+0.05%F.S.		
Constant Voltage Mode	Range	0~150V	0~600V	0~1200V	0~150V	0~600V	0~1200V
	Resolution	1mV	5mV	10mV	1mV	5mV	10mV
	Accuracy	0.025%+0.025%F.S.			0.025%+0.025%F.S.		
Constant Power Mode	Range	0~1540W	0~7700W	0~15400W	0~1690W	0~8450W	0~16900W
	Resolution	40mW	200mW	400mW	40mW	200mW	400mW
	Accuracy	0.2%+0.2%F.S.			0.2%+0.2%F.S.		
Constant Resistance Mode	Range	21mΩ~210Ω(150V)	85mΩ~850Ω(600V)	850mΩ~1700Ω(1200V)	21mΩ~210Ω(150V)	85mΩ~850Ω(600V)	850mΩ~1700Ω(1200V)
	Resolution	21mΩ(150V)	85mΩ(600V)	850mΩ(1200V)	21mΩ(150V)	85mΩ(600V)	850mΩ(1200V)
	Accuracy	Vin/Rset*(0.2%)+0.2% I.F.S.			Vin/Rset*(0.2%)+0.2% I.F.S.		
Dynamic Mode							
CCD/CRD	T1&T2(Pro.)	0.02ms~300s			0.02ms~300s		
	T1&T2(Adv.)	0.05ms~300s			0.05ms~300s		
	Resolution	1μs			1μs		
	Accuracy	1μs+100ppm			1μs+100ppm		
	Slew Rate(Pro.)	0.5mA/μs~1.8A/μs	2mA/μs~9A/μs	5mA/μs~18A/μs	0.5mA/μs~1.8A/μs	2mA/μs~9A/μs	5mA/μs~18A/μs
	Slew Rate(Adv.)	0.5mA/μs~0.56A/μs	2mA/μs~2.8A/μs	5mA/μs~5.6A/μs	0.5mA/μs~0.62A/μs	2mA/μs~3.1A/μs	5mA/μs~6.2A/μs
	Min. Rise Time(Pro.)	20μs(Typical)			20μs(Typical)		
	Min. Rise Time(Adv.)	50μs(Typical)			50μs(Typical)		
	Resolution	0.5mA/μs	2mA/μs	5mA/μs	0.5mA/μs	2mA/μs	5mA/μs
	Accuracy	5%±10us			5%±10us		
Measurement							
Voltage	Range	0~150V	0~600V	0~1200V	0~150V	0~600V	0~1200V
	Resolution	1mV	5mV	10mV	1mV	5mV	10mV
	Accuracy	0.015%+0.015%F.S.			0.015%+0.015%F.S.		
Current	Range	0~56A	0~280A	0~560A	0~62A	0~310A	0~620A
	Resolution	0.5mA	2mA	5mA	0.5mA	2mA	5mA
	Accuracy	0.04%+0.06%F.S.			0.04%+0.06%F.S.		
Power	Range	0~1540W	0~7700W	0~15400W	0~1690W	0~8450W	0~16900W
	Resolution	40mW	200mW	400mW	40mW	200mW	400mW
	Accuracy	0.1%+0.1%F.S.			0.1%+0.1%F.S.		
Sampling Frequency	500kHz			500kHz			
Protection							
OVP	165V	660V	1320V	165V	660V	1320V	
OCP	57.12A	285.6A	571.2A	63.24A	316.2A	632.4A	
OPP	1586.2W	7931W	15862W	1740.7W	8703.5W	17407W	
Over Temperature	70-75°C			70-75°C			
Overvoltage Safety Value	110%V.F.S.			110%V.F.S.			
Reverse Alarm	Yes			Yes			
Alarm Tone	Yes			Yes			
Mechanical							
Dimensions(WxHxD)	423.0x444.0x670.0 mm			423.0x444.0x670.0 mm			
Package Dimensions(WxHxD)	544.0x741.0x891.0 mm			544.0x741.0x891.0 mm			
Unit Weight	94.5kg			98.5kg			
Shipping Weight	116.5kg			120.5kg			
AC Input							
Voltage	100~240Vac			100~240Vac			
Frequency	50~60Hz			50~60Hz			
Power	700VA			750VA			
Fuse	8A			8A			

EL Series High-density Programmable DC Electronic Load

MODEL		EL1200VDC17600W			EL1200VDC19100W		
Rated	Voltage	0~1200V			0~1200V		
	Current	0~640A			0~700A		
	Power	0~17600W			0~19100W		
	Min. Operating Voltage	2V@64A	10V@320A	20V@640A	2V@70A	10V@350A	20V@700A
Static Mode							
Constant Current Mode	Range	0~64A	0~320A	0~640A	0~70A	0~350A	0~700A
	Resolution	0.5mA	2mA	5mA	0.5mA	2mA	5mA
	Accuracy	0.05%+0.05%F.S.			0.05%+0.05%F.S.		
Constant Voltage Mode	Range	0~150V	0~600V	0~1200V	0~150V	0~600V	0~1200V
	Resolution	1mV	5mV	10mV	1mV	5mV	10mV
	Accuracy	0.025%+0.025%F.S.			0.025%+0.025%F.S.		
Constant Power Mode	Range	0~1760W	0~8800W	0~17600W	0~1910W	0~9550W	0~19100W
	Resolution	100mW	500mW	1000mW	100mW	500mW	1000mW
	Accuracy	0.2%+0.2%F.S.			0.2%+0.2%F.S.		
Constant Resistance Mode	Range	18.7mΩ~187Ω(150V)	75mΩ~750Ω(600V)	750mΩ~1500Ω(1200V)	18.7mΩ~187Ω(150V)	75mΩ~750Ω(600V)	750mΩ~1500Ω(1200V)
	Resolution	18.7mΩ(150V)	75mΩ(600V)	750mΩ(1200V)	18.7mΩ(150V)	75mΩ(600V)	750mΩ(1200V)
	Accuracy	Vin/Rset*(0.2%)+0.2% I.F.S.			Vin/Rset*(0.2%)+0.2% I.F.S.		
Dynamic Mode							
CCD/CRD	T1&T2(Pro.)	0.02ms~300s			0.02ms~300s		
	T1&T2(Adv.)	0.05ms~300s			0.05ms~300s		
	Resolution	1μs			1μs		
	Accuracy	1μs+100ppm			1μs+100ppm		
	Slew Rate(Pro.)	0.5mA/μs~1.92A/μs	2mA/μs~9.6A/μs	5mA/μs~19.2A/μs	0.5mA/μs~1.92A/μs	2mA/μs~9.6A/μs	5mA/μs~19.2A/μs
	Slew Rate(Adv.)	0.5mA/μs~0.64A/μs	2mA/μs~3.2A/μs	5mA/μs~6.4A/μs	0.5mA/μs~0.7A/μs	2mA/μs~3.5A/μs	5mA/μs~7A/μs
	Min. Rise Time(Pro.)	20μs(Typical)			20μs(Typical)		
	Min. Rise Time(Adv.)	50μs(Typical)			50μs(Typical)		
	Resolution	0.5mA/μs	2mA/μs	5mA/μs	0.5mA/μs	2mA/μs	5mA/μs
	Accuracy	5%±10us			5%±10us		
Measurement							
Voltage	Range	0~150V	0~600V	0~1200V	0~150V	0~600V	0~1200V
	Resolution	1mV	5mV	10mV	1mV	5mV	10mV
	Accuracy	0.015%+0.015%F.S.			0.015%+0.015%F.S.		
Current	Range	0~64A	0~320A	0~640A	0~70A	0~350A	0~700A
	Resolution	0.5mA	2mA	5mA	0.5mA	2mA	5mA
	Accuracy	0.04%+0.06%F.S.			0.04%+0.06%F.S.		
Power	Range	0~1760W	0~8800W	0~17600W	0~1910W	0~9550W	0~19100W
	Resolution	100mW	500mW	1000mW	100mW	500mW	1000mW
	Accuracy	0.1%+0.1%F.S.			0.1%+0.1%F.S.		
Sampling Frequency	500kHz			500kHz			
Protection							
OVP	165V	660V	1320V	165V	660V	1320V	
OCP	65.28A	326.4A	652.8A	71.4A	357A	714A	
OPP	1812.8W	9064W	18128W	1967.3W	9836.5W	19673W	
Over Temperature	70-75°C			70-75°C			
Overvoltage Safety Value	110%V.F.S.			110%V.F.S.			
Reverse Alarm	Yes			Yes			
Alarm Tone	Yes			Yes			
Mechanical							
Dimensions(WxHxD)	423.0x444.0x670.0 mm			423.0x444.0x670.0 mm			
Package Dimensions(WxHxD)	544.0x741.0x891.0 mm			544.0x741.0x891.0 mm			
Unit Weight	100kg			104kg			
Shipping Weight	122kg			126kg			
AC Input							
Voltage	100~240Vac			100~240Vac			
Frequency	50~60Hz			50~60Hz			
Power	750VA			800VA			
Fuse	8A			8A			

EL Series High-density Programmable DC Electronic Load

MODEL		EL1200VDC19800W			EL1200VDC21300W		
Rated	Voltage	0~1200V			0~1200V		
	Current	0~720A			0~780A		
	Power	0~19800W			0~21300W		
	Min. Operating Voltage	2V@72A	10V@360A	20V@720A	2V@78A	10V@390A	20V@780A
Static Mode							
Constant Current Mode	Range	0~72A	0~360A	0~720A	0~78A	0~390A	0~780A
	Resolution	0.5mA	2mA	5mA	0.5mA	2mA	5mA
	Accuracy	0.05%+0.05%F.S.			0.05%+0.05%F.S.		
Constant Voltage Mode	Range	0~150V	0~600V	0~1200V	0~150V	0~600V	0~1200V
	Resolution	1mV	5mV	10mV	1mV	5mV	10mV
	Accuracy	0.025%+0.025%F.S.			0.025%+0.025%F.S.		
Constant Power Mode	Range	0~1980W	0~9900W	0~19800W	0~2130W	0~10650W	0~21300W
	Resolution	100mW	500mW	1000mW	100mW	500mW	1000mW
	Accuracy	0.2%+0.2%F.S.			0.2%+0.2%F.S.		
Constant Resistance Mode	Range	16.7mΩ~166.7Ω(150V)	66.7mΩ~666Ω(600V)	666.7mΩ~1333Ω(1200V)	16.7mΩ~166.7Ω(150V)	66.7mΩ~666Ω(600V)	666.7mΩ~1333Ω(1200V)
	Resolution	16.7mΩ(150V)	66.7mΩ(600V)	666.7mΩ(1200V)	16.7mΩ(150V)	66.7mΩ(600V)	666.7mΩ(1200V)
	Accuracy	Vin/Rset*(0.2%)+0.2% I.F.S.			Vin/Rset*(0.2%)+0.2% I.F.S.		
Dynamic Mode							
CCD/CRD	T1&T2(Pro.)	0.02ms~300s			0.02ms~300s		
	T1&T2(Adv.)	0.05ms~300s			0.05ms~300s		
	Resolution	1μs			1μs		
	Accuracy	1μs+100ppm			1μs+100ppm		
	Slew Rate(Pro.)	0.5mA/μs~2A/μs	2mA/μs~10A/μs	5mA/μs~20A/μs	0.5mA/μs~2A/μs	2mA/μs~10A/μs	5mA/μs~20A/μs
	Slew Rate(Adv.)	0.5mA/μs~0.72A/μs	2mA/μs~3.6A/μs	5mA/μs~7.2A/μs	0.5mA/μs~0.78A/μs	2mA/μs~3.9A/μs	5mA/μs~7.8A/μs
	Min. Rise Time(Pro.)	20μs(Typical)			20μs(Typical)		
	Min. Rise Time(Adv.)	50μs(Typical)			50μs(Typical)		
	Resolution	0.5mA/μs	2mA/μs	5mA/μs	0.5mA/μs	2mA/μs	5mA/μs
	Accuracy	5%±10us			5%±10us		
Measurement							
Voltage	Range	0~150V	0~600V	0~1200V	0~150V	0~600V	0~1200V
	Resolution	1mV	5mV	10mV	1mV	5mV	10mV
	Accuracy	0.015%+0.015%F.S.			0.015%+0.015%F.S.		
Current	Range	0~72A	0~360A	0~720A	0~78A	0~390A	0~780A
	Resolution	0.5mA	2mA	5mA	0.5mA	2mA	5mA
	Accuracy	0.04%+0.06%F.S.			0.04%+0.06%F.S.		
Power	Range	0~1980W	0~9900W	0~19800W	0~2130W	0~10650W	0~21300W
	Resolution	100mW	500mW	1000mW	100mW	500mW	1000mW
	Accuracy	0.1%+0.1%F.S.			0.1%+0.1%F.S.		
Sampling Frequency	500kHz			500kHz			
Protection							
OVP	165V	660V	1320V	165V	660V	1320V	
OCP	73.44A	367.2A	734.4A	79.56A	397.8A	795.6A	
OPP	2039.4W	10197W	20394W	2193.9W	10969.5W	21939W	
Over Temperature	70-75°C			70-75°C			
Overvoltage Safety Value	110%V.F.S.			110%V.F.S.			
Reverse Alarm	Yes			Yes			
Alarm Tone	Yes			Yes			
Mechanical							
Dimensions(WxHxD)	423.0x444.0x670.0 mm			423.0x444.0x670.0 mm			
Package Dimensions(WxHxD)	544.0x741.0x891.0 mm			544.0x741.0x891.0 mm			
Unit Weight	105.5kg			109.5kg			
Shipping Weight	127.5kg			131.5kg			
AC Input							
Voltage	100~240Vac			100~240Vac			
Frequency	50~60Hz			50~60Hz			
Power	800VA			850VA			
Fuse	8A			8A			

EL Series High-density Programmable DC Electronic Load

MODEL		EL1200VDC22000W			EL1200VDC23500W		
Rated	Voltage	0~1200V			0~1200V		
	Current	0~800A			0~860A		
	Power	0~22000W			0~23500W		
	Min. Operating Voltage	2V@80A	10V@400A	20V@800A	2V@86A	10V@430A	20V@860A
Static Mode							
Constant Current Mode	Range	0~80A	0~400A	0~800A	0~86A	0~430A	0~860A
	Resolution	1mA	5mA	10mA	1mA	5mA	10mA
	Accuracy	0.05%+0.05%F.S.			0.05%+0.05%F.S.		
Constant Voltage Mode	Range	0~150V	0~600V	0~1200V	0~150V	0~600V	0~1200V
	Resolution	1mV	5mV	10mV	1mV	5mV	10mV
	Accuracy	0.025%+0.025%F.S.			0.025%+0.025%F.S.		
Constant Power Mode	Range	0~2200W	0~11000W	0~22000W	0~2350W	0~11750W	0~23500W
	Resolution	100mW	500mW	1000mW	100mW	500mW	1000mW
	Accuracy	0.2%+0.2%F.S.			0.2%+0.2%F.S.		
Constant Resistance Mode	Range	15mΩ~150Ω(150V)	60mΩ~600Ω(600V)	600mΩ~1200Ω(1200V)	15mΩ~150Ω(150V)	60mΩ~600Ω(600V)	600mΩ~1200Ω(1200V)
	Resolution	15mΩ(150V)	60mΩ(600V)	600mΩ(1200V)	15mΩ(150V)	60mΩ(600V)	600mΩ(1200V)
	Accuracy	Vin/Rset*(0.2%)+0.2% I.F.S.			Vin/Rset*(0.2%)+0.2% I.F.S.		
Dynamic Mode							
CCD/CRD	T1&T2(Pro.)	0.02ms~300s			0.02ms~300s		
	T1&T2(Adv.)	0.05ms~300s			0.05ms~300s		
	Resolution	1μs			1μs		
	Accuracy	1μs+100ppm			1μs+100ppm		
	Slew Rate(Pro.)	1mA/μs~2.1A/μs	5mA/μs~10.5A/μs	10mA/μs~21A/μs	1mA/μs~2.1A/μs	5mA/μs~10.5A/μs	10mA/μs~21A/μs
	Slew Rate(Adv.)	1mA/μs~0.8A/μs	5mA/μs~4A/μs	10mA/μs~8A/μs	1mA/μs~0.86A/μs	5mA/μs~4.3A/μs	10mA/μs~8.6A/μs
	Min. Rise Time(Pro.)	20μs(Typical)			20μs(Typical)		
	Min. Rise Time(Adv.)	50μs(Typical)			50μs(Typical)		
	Resolution	1mA/μs	5mA/μs	10mA/μs	1mA/μs	5mA/μs	10mA/μs
	Accuracy	5%±10us			5%±10us		
Measurement							
Voltage	Range	0~150V	0~600V	0~1200V	0~150V	0~600V	0~1200V
	Resolution	1mV	5mV	10mV	1mV	5mV	10mV
	Accuracy	0.015%+0.015%F.S.			0.015%+0.015%F.S.		
Current	Range	0~80A	0~400A	0~800A	0~86A	0~430A	0~860A
	Resolution	1mA	5mA	10mA	1mA	5mA	10mA
	Accuracy	0.04%+0.06%F.S.			0.04%+0.06%F.S.		
Power	Range	0~2200W	0~11000W	0~22000W	0~2350W	0~11750W	0~23500W
	Resolution	100mW	500mW	1000mW	100mW	500mW	1000mW
	Accuracy	0.1%+0.1%F.S.			0.1%+0.1%F.S.		
Sampling Frequency	500kHz			500kHz			
Protection							
OVP	165V	660V	1320V	165V	660V	1320V	
OCP	81.6A	408A	816A	87.72A	438.6A	877.2A	
OPP	2266W	11330W	22660W	2420.5W	12102.5W	24205W	
Over Temperature	70-75°C			70-75°C			
Overvoltage Safety Value	110%V.F.S.			110%V.F.S.			
Reverse Alarm	Yes			Yes			
Alarm Tone	Yes			Yes			
Mechanical							
Dimensions(WxHxD)	423.0x577.0x670.0 mm			423.0x577.0x670.0 mm			
Package Dimensions(WxHxD)	541.0x861.0x891.0 mm			541.0x861.0x891.0 mm			
Unit Weight	129kg			133kg			
Shipping Weight	153kg			157kg			
AC Input							
Voltage	100~240Vac			100~240Vac			
Frequency	50~60Hz			50~60Hz			
Power	950VA			1000VA			
Fuse	10A			10A			

EL Series High-density Programmable DC Electronic Load

MODEL		EL1200VDC24200W			EL1200VDC25700W		
Rated	Voltage	0~1200V			0~1200V		
	Current	0~880A			0~940A		
	Power	0~24200W			0~25700W		
	Min. Operating Voltage	2V@88A	10V@440A	20V@880A	2V@94A	10V@470A	20V@940A
Static Mode							
Constant Current Mode	Range	0~88A	0~440A	0~880A	0~94A	0~470A	0~940A
	Resolution	1mA	5mA	10mA	1mA	5mA	10mA
	Accuracy	0.05%+0.05%F.S.			0.05%+0.05%F.S.		
Constant Voltage Mode	Range	0~150V	0~600V	0~1200V	0~150V	0~600V	0~1200V
	Resolution	1mV	5mV	10mV	1mV	5mV	10mV
	Accuracy	0.025%+0.025%F.S.			0.025%+0.025%F.S.		
Constant Power Mode	Range	0~2420W	0~12100W	0~24200W	0~2570W	0~12850W	0~25700W
	Resolution	100mW	500mW	1000mW	100mW	500mW	1000mW
	Accuracy	0.2%+0.2%F.S.			0.2%+0.2%F.S.		
Constant Resistance Mode	Range	13.6mΩ~136Ω(150V)	55mΩ~550Ω(600V)	550mΩ~1100Ω(1200V)	13.6mΩ~136Ω(150V)	55mΩ~550Ω(600V)	550mΩ~1100Ω(1200V)
	Resolution	13.6mΩ(150V)	55mΩ(600V)	550mΩ(1200V)	13.6mΩ(150V)	55mΩ(600V)	550mΩ(1200V)
	Accuracy	Vin/Rset*(0.2%)+0.2% I.F.S.			Vin/Rset*(0.2%)+0.2% I.F.S.		
Dynamic Mode							
CCD/CRD	T1&T2(Pro.)	0.02ms~300s			0.02ms~300s		
	T1&T2(Adv.)	0.05ms~300s			0.05ms~300s		
	Resolution	1μs			1μs		
	Accuracy	1μs+100ppm			1μs+100ppm		
	Slew Rate(Pro.)	1mA/μs~2.2A/μs	5mA/μs~11A/μs	10mA/μs~22A/μs	1mA/μs~2.2A/μs	5mA/μs~11A/μs	10mA/μs~22A/μs
	Slew Rate(Adv.)	1mA/μs~0.88A/μs	5mA/μs~4.4A/μs	10mA/μs~8.8A/μs	1mA/μs~0.94A/μs	5mA/μs~4.7A/μs	10mA/μs~9.4A/μs
	Min. Rise Time(Pro.)	20μs(Typical)			20μs(Typical)		
	Min. Rise Time(Adv.)	50μs(Typical)			50μs(Typical)		
	Resolution	1mA/μs	5mA/μs	10mA/μs	1mA/μs	5mA/μs	10mA/μs
	Accuracy	5%±10us			5%±10us		
Measurement							
Voltage	Range	0~150V	0~600V	0~1200V	0~150V	0~600V	0~1200V
	Resolution	1mV	5mV	10mV	1mV	5mV	10mV
	Accuracy	0.015%+0.015%F.S.			0.015%+0.015%F.S.		
Current	Range	0~88A	0~440A	0~880A	0~94A	0~470A	0~940A
	Resolution	1mA	5mA	10mA	1mA	5mA	10mA
	Accuracy	0.04%+0.06%F.S.			0.04%+0.06%F.S.		
Power	Range	0~2420W	0~12100W	0~24200W	0~2570W	0~12850W	0~25700W
	Resolution	100mW	500mW	1000mW	100mW	500mW	1000mW
	Accuracy	0.1%+0.1%F.S.			0.1%+0.1%F.S.		
Sampling Frequency	500kHz			500kHz			
Protection							
OVP	165V	660V	1320V	165V	660V	1320V	
OCP	89.76A	448.8A	897.6A	95.88A	479.4A	958.8A	
OPP	2492.6W	12463W	24926W	2647.1W	13235.5W	26471W	
Over Temperature	70-75°C			70-75°C			
Overvoltage Safety Value	110%V.F.S.			110%V.F.S.			
Reverse Alarm	Yes			Yes			
Alarm Tone	Yes			Yes			
Mechanical							
Dimensions(WxHxD)	423.0x577.0x670.0 mm			423.0x577.0x670.0 mm			
Package Dimensions(WxHxD)	541.0x861.0x891.0 mm			541.0x861.0x891.0 mm			
Unit Weight	134.5kg			134.5kg			
Shipping Weight	158.5kg			158.5kg			
AC Input							
Voltage	100~240Vac			100~240Vac			
Frequency	50~60Hz			50~60Hz			
Power	1000VA			1050VA			
Fuse	10A			10A			

EL Series High-density Programmable DC Electronic Load

MODEL		EL1200VDC26400W			EL1200VDC27900W		
Rated	Voltage	0~1200V			0~1200V		
	Current	0~960A			0~1020A		
	Power	0~26400W			0~27900W		
	Min. Operating Voltage	2V@96A	10V@480A	20V@960A	2V@102A	10V@510A	20V@1020A
Static Mode							
Constant Current Mode	Range	0~96A	0~480A	0~960A	0~102A	0~510A	0~1020A
	Resolution	1mA	5mA	10mA	1mA	5mA	10mA
	Accuracy	0.05%+0.05%F.S.			0.05%+0.05%F.S.		
Constant Voltage Mode	Range	0~150V	0~600V	0~1200V	0~150V	0~600V	0~1200V
	Resolution	1mV	5mV	10mV	1mV	5mV	10mV
	Accuracy	0.025%+0.025%F.S.			0.025%+0.025%F.S.		
Constant Power Mode	Range	0~2640W	0~13200W	0~26400W	0~2790W	0~13950W	0~27900W
	Resolution	100mW	500mW	1000mW	100mW	500mW	1000mW
	Accuracy	0.2%+0.2%F.S.			0.2%+0.2%F.S.		
Constant Resistance Mode	Range	12.5mΩ~125Ω(150V)	50mΩ~500Ω(600V)	500mΩ~1000Ω(1200V)	12.5mΩ~125Ω(150V)	50mΩ~500Ω(600V)	500mΩ~1000Ω(1200V)
	Resolution	12.5mΩ(150V)	50mΩ(600V)	500mΩ(1200V)	12.5mΩ(150V)	50mΩ(600V)	500mΩ(1200V)
	Accuracy	Vin/Rset*(0.2%)+0.2% I.F.S.			Vin/Rset*(0.2%)+0.2% I.F.S.		
Dynamic Mode							
CCD/CRD	T1&T2(Pro.)	0.02ms~300s			0.02ms~300s		
	T1&T2(Adv.)	0.05ms~300s			0.05ms~300s		
	Resolution	1μs			1μs		
	Accuracy	1μs+100ppm			1μs+100ppm		
	Slew Rate(Pro.)	1mA/μs~2.4A/μs	5mA/μs~12A/μs	10mA/μs~24A/μs	1mA/μs~2.4A/μs	5mA/μs~12A/μs	10mA/μs~24A/μs
	Slew Rate(Adv.)	1mA/μs~0.96A/μs	5mA/μs~4.8A/μs	10mA/μs~9.6A/μs	1mA/μs~1.02A/μs	5mA/μs~5.1A/μs	10mA/μs~10.2A/μs
	Min. Rise Time(Pro.)	20μs(Typical)			20μs(Typical)		
	Min. Rise Time(Adv.)	50μs(Typical)			50μs(Typical)		
	Resolution	1mA/μs	5mA/μs	10mA/μs	1mA/μs	5mA/μs	10mA/μs
	Accuracy	5%±10us			5%±10us		
Measurement							
Voltage	Range	0~150V	0~600V	0~1200V	0~150V	0~600V	0~1200V
	Resolution	1mV	5mV	10mV	1mV	5mV	10mV
	Accuracy	0.015%+0.015%F.S.			0.015%+0.015%F.S.		
Current	Range	0~96A	0~480A	0~960A	0~102A	0~510A	0~1020A
	Resolution	1mA	5mA	10mA	1mA	5mA	10mA
	Accuracy	0.04%+0.06%F.S.			0.04%+0.06%F.S.		
Power	Range	0~2640W	0~13200W	0~26400W	0~2790W	0~13950W	0~27900W
	Resolution	100mW	500mW	1000mW	100mW	500mW	1000mW
	Accuracy	0.1%+0.1%F.S.			0.1%+0.1%F.S.		
Sampling Frequency	500kHz			500kHz			
Protection							
OVP	165V	660V	1320V	165V	660V	1320V	
OCP	97.92A	489.6A	979.2A	104.04A	520.2A	1040.4A	
OPP	2719.2W	13596W	27192W	2873.7W	14368.5W	28737W	
Over Temperature	70-75°C			70-75°C			
Overvoltage Safety Value	110%V.F.S.			110%V.F.S.			
Reverse Alarm	Yes			Yes			
Alarm Tone	Yes			Yes			
Mechanical							
Dimensions(WxHxD)	423.0x577.0x670.0 mm			423.0x577.0x670.0 mm			
Package Dimensions(WxHxD)	541.0x861.0x891.0 mm			541.0x861.0x891.0 mm			
Unit Weight	140kg			144kg			
Shipping Weight	164kg			168kg			
AC Input							
Voltage	100~240Vac			100~240Vac			
Frequency	50~60Hz			50~60Hz			
Power	1050VA			1100VA			
Fuse	10A			10A			

EL Series High-density Programmable DC Electronic Load

1200V Series System Specifications			
Non Linear Mode			
Range	CL	30uF~5000uF	
	RL	As CR Mode	
	Ls	0.1uH~16uH	
	Rs	30mΩ~20Ω	
Resolution	CL	1uF	
	RL	As CR Mode	
	Ls	0.1uH	
	Rs	1mΩ	
Battery Discharge Mode			
Battery Voltage	As CV Mode		
Current Resolution	As CC Mode		
Record	AH/WH		
Test Time	1s~100000s		
Time Resolution	1s		
Program Mode			
Step No.	300 Max.		
Dwell	0.1ms~4000s		
Spec Check	Voltage/Current/Power		
External Waveform Control/Monitor			
Control/Monitor	Voltage/Current		
Input/Output Range	0~10V		
Voltage Range	0~L_range F.S.	0~M_range F.S.	0~H_range F.S.
Current Range	0~L_range F.S.	0~M_range F.S.	0~H_range F.S.
Accuracy	0.4%F.S.		
Resolution	4mV		
Bandwidth	20kHz		
Input Impedance	10kΩ		
Short Circuit			
Current(CC)	Full range current value		
Voltage(CV)	Voltage value at the Max power in working mode		
Resistance(CR)	Min resistance value of CR Mode		
Master/Slave			
Parallel Interface	RJ45		
Parallel Quantity (Pro.)	20 units		
Parallel Quantity (Adv.)	20 units		
General			
Graphic Display	4.3" Color touch LCD		
Operation Key Feature	Soft key, Numeric key, Rotary Knob, USB port for transfer and upgrading firmware		
Rack Mount Handles	Yes		
FAN	Temperature Control		
Interface	RS232/RS485/USB(Standard), GPIB/LAN(Optional)		
Communication Response Time	30ms		
Storage Capacity	User defined settings (300 sets), OCP settings (10 sets), OPP settings (10 sets), Default settings (1 set), Factory setting (1 set)		
Environmental			
Operating Temperature	0~40°C		
Storage Temperature	-20~80°C		
Temperature Coefficient	100ppm/°C(Typical)		
Relative Humidity	10~90%RH		
Altitude	<2000m		
Regulatory Compliance			
Overvoltage Category	II		
Protection Degree	I		
Pollution Degree	II		
Input Impedance	2MΩ(Typical)		
Isolation Voltage	/		
Certificates	CE		

All specifications are subject to change without notice.

EL Series High-density Programmable DC Electronic Load

PS :

1. Min. operation voltage is applied for current high range.
2. F.S. in power accuracy formula equals to V range F.S. times I range F.S.
3. Minimum rise time is valid only for loading current > 5%F.S.
4. If the operating voltage exceeds the rated voltage for 1.1 times, it will cause permanent damage to the unit.
5. The over temperature protection sampling point is located in the vent.
6. The measured noise is 79dB which is tested under the condition of 40°C ambient temperature with full power for 5 minutes and 1 meter away from the rear panel.
7. The power rating specifications of 1200V models as below.

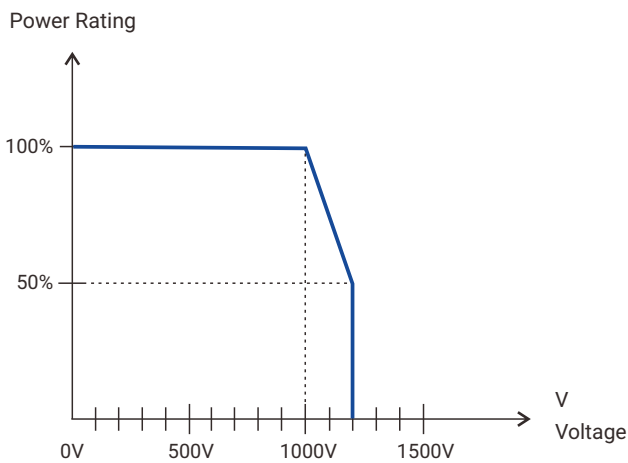

8. All the specifications are tested at temperature of 25°C, unless otherwise noted. See the diagram below for power derating.

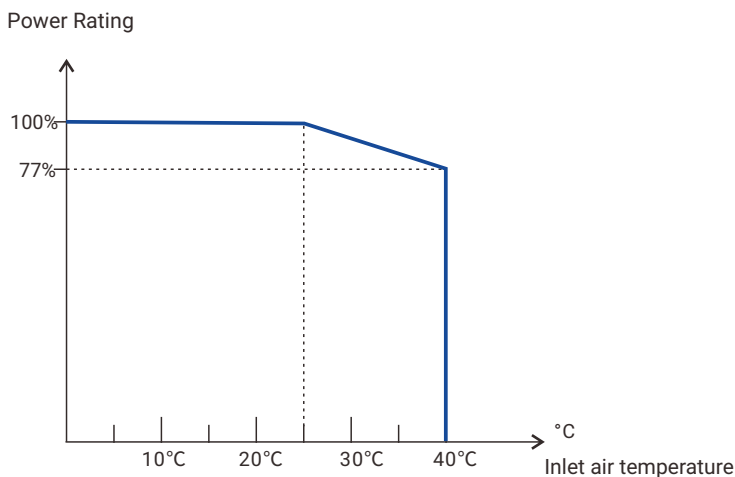

9. Each model size indicated here does not include the wheel and the protective cover.

APM Technologies Ltd

Add: #7, Link Industry Park, Kechuang Road, Nancheng,
Dongguan, Guangdong, China

Tel: +86 769-8698 9800 ext:8901

E-mail: overseas@apmtech.cn

Web: www.apmtechate.com



Scan the QR code for more information